

RELAP-7 Development Status

International RELAP5 Users Group Meeting and Seminar
Training Workshop, April 18-19, 2019

Richard Martineau, James Wolf, George Mesina, and David Andrs

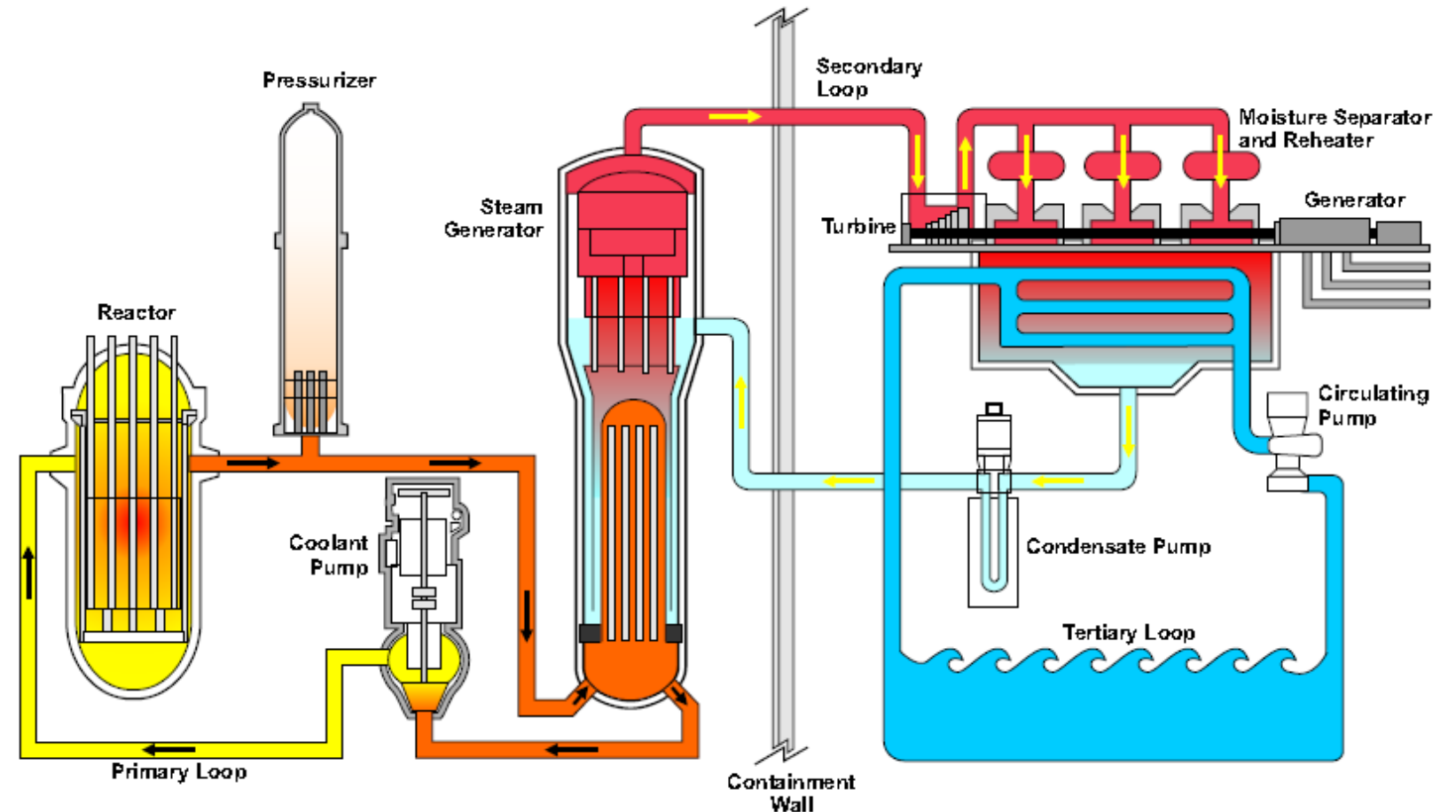

www.inl.gov



Presentation Overview

1. RELAP-7 Introduction and History
2. RELAP-7 Development Goals
3. Current Algorithmic Approach
4. Advanced Multiphysics
5. Summary of “what RELAP-7 can do now”
6. The next three years
7. Summary of RELAP5-3D to RELAP-7 Transition
8. Questions

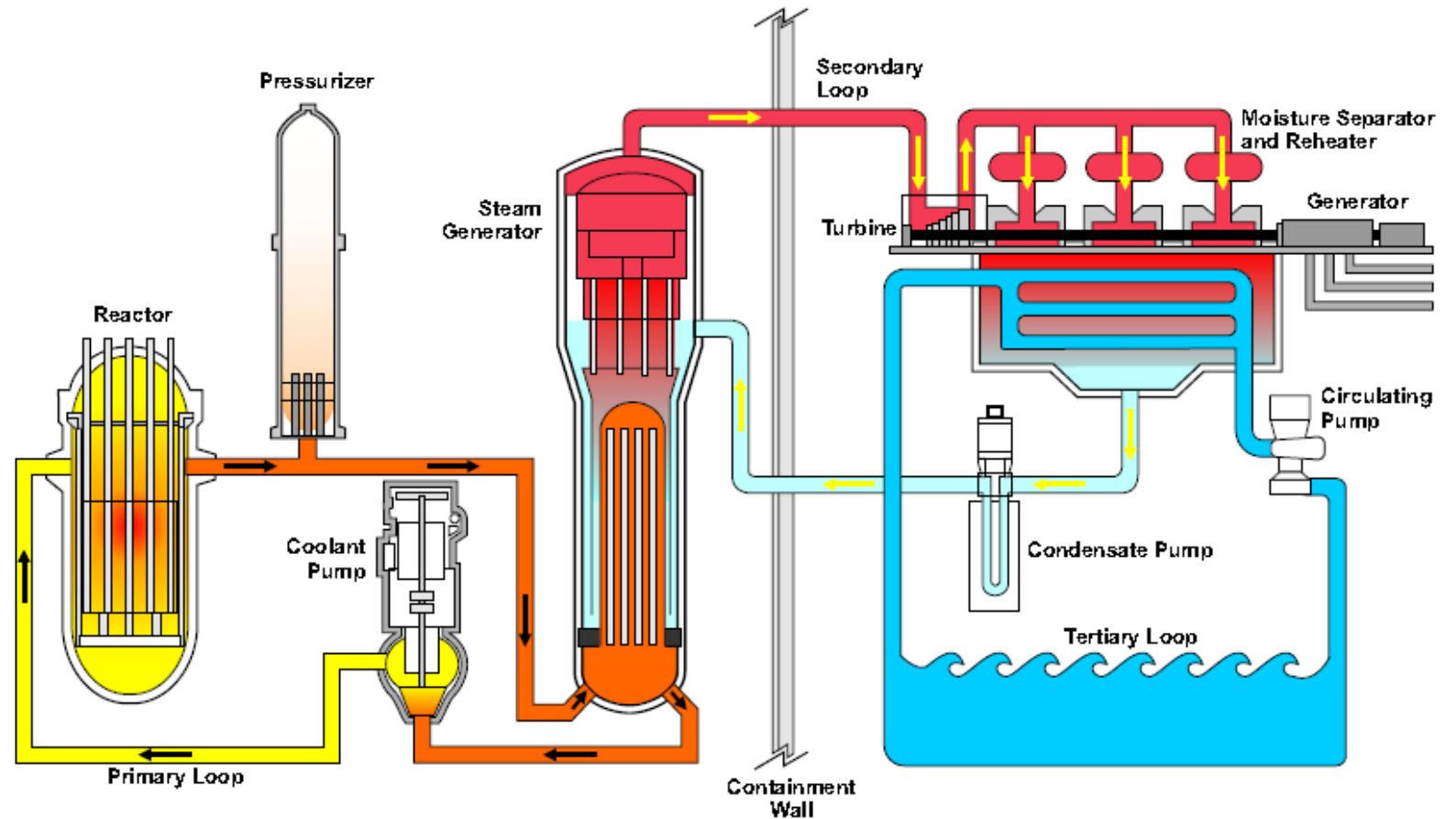

RELAP-7 Introduction and History

RELAP-7: The Next Generation Nuclear Reactor System/Safety Analysis Tool being developed at INL.

- RELAP-7 development began under the Nuclear Energy Advanced Modeling and Simulation (NEAMS) in FY-2012 to support the Risk Informed Safety Margins Characterization (RISMC) Pathway of the Light Water Reactor Sustainability (LWRS) program.
- First lines of code were committed to the INL repository on Monday, November 7th, 2011.
- RELAP-7's planned capabilities and range of applicability include the current fleet of LWRs, as well next generation LWRs, and the various Advanced Reactor Concepts.
- Post Fukushima regulatory requirements, such as 10 CFR 50.46c and uncertainty quantification are planned improvements in RELAP-7.
- Proof of concept result, TMI-1 single phase primary loops, steady-state, 06/13/2012.
- By the end of FY-2019, \$16.75M of the projected \$25M required funding will have been expended.

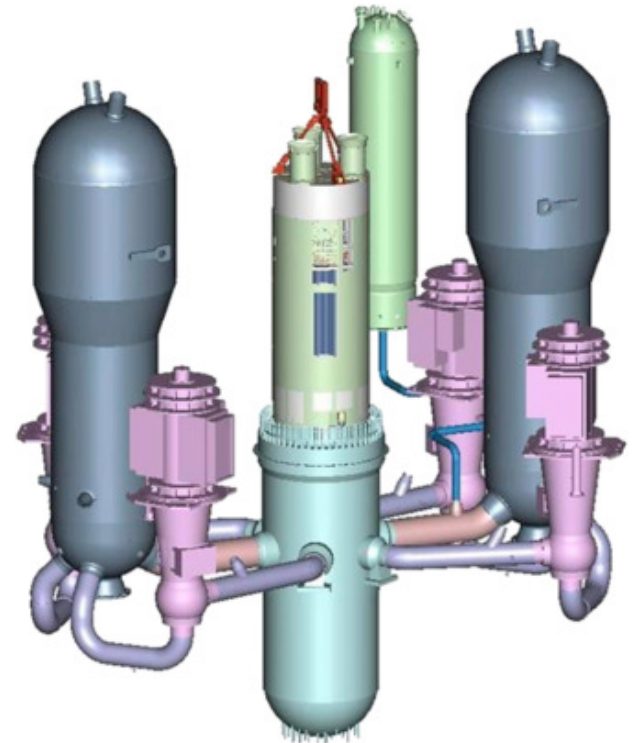

RELAP-7 Development Goals

RELAP-7 Design Concept

The overall design goal of RELAP-7 development is to leverage 30 years of advancements in software design, numerical integration methods, and physical models.

- **Modern Software Design:** *What MOOSE brings to the table.*
 - Object-oriented C++ construction (www.mooseframework.org)
 - Designed to be easily extended (modular physics) and maintained
 - Strict adherence to SQA (meeting NQA-1 requirements)
- **Advanced Numerical Integration Methods:**
 - Multi-scale time integration, PCICE (in progress), JFNK (implicit nonlinear Newton method), and a point implicit method. Second-order accurate spatial discretization (linear finite elements or reconstructed Discontinuous Galerkin).
- **State-of-the-Art Physical Models:**
 - All-speed, all-fluid (vapor-liquid, gas, liquid metal) flow – agnostic of reactor concept (PWR, BWR, SMR, SFR, LFR, MSR, FHR, VHTR, HTTR, GFR, etc.).
 - 7-equation two-phase, two-pressure flow model incorporating IAPWS-95 equation of state.
 - Closure relations from the TRACE V5.0 code.
 - Designed for multiphysics analysis (BISON, Marmot, MAMMOTH, Rattlesnake) or to couple to multi-D core simulators (CASL's VERA or NEAMS Pronghorn) with MOOSE MultiApp and Transfers.

Current Algorithmic Approach

Computational Approach

Multiphysics Coupling:

- Loose coupling – One-way data transfer
- Tight coupling – Picard Iteration (Point-Implicit)
- Strong Coupling – Full Newton and Jacobian-Free Newton Krylov

Temporal Integration:

- Implicit Backward Euler (1st-order)
- BDF2 – Backward Difference Formula (Implicit 2nd-order)
- Crank-Nicolson (Implicit 2nd-order)
- Explicit Runge-Kutta (arbitrary order)
- Semi-Implicit Predictor-Corrector ICE (2nd-order)

Spatial Discretization:

- Continuous Galerkin Finite Element (2nd-order)
- Reconstructed Discontinuous Galerkin Finite Element (1st or 2nd-order)

Advanced Multiphysics

Easily coupling MOOSE-based software applications to non-native or legacy software codes is a huge advantage with MOOSE

- MOOSE contains a novel approach to code coupling, for both MOOSE-based applications and external codes.
- The approach consists the MultiApp system, which allows multiple MOOSE (or external) applications to run simultaneously in parallel and the the Transfer system, which is designed to push and pull fields and data to and from MultiApps. “MultiApp and Transfers” is the approach for
- Multiple codes are compiled into one executable, can efficiently exchange data in memory, and effectively converge all coefficients in an implicit iterative manner (Picard).
- OpenMC and Serpent neutron transport Monte Carlo codes have been coupled in the “MOOSE-wrapped Apps” manner to BISON. MCNP and MC21 is next. ANL’s Nek5000 CFD code has also been coupled.

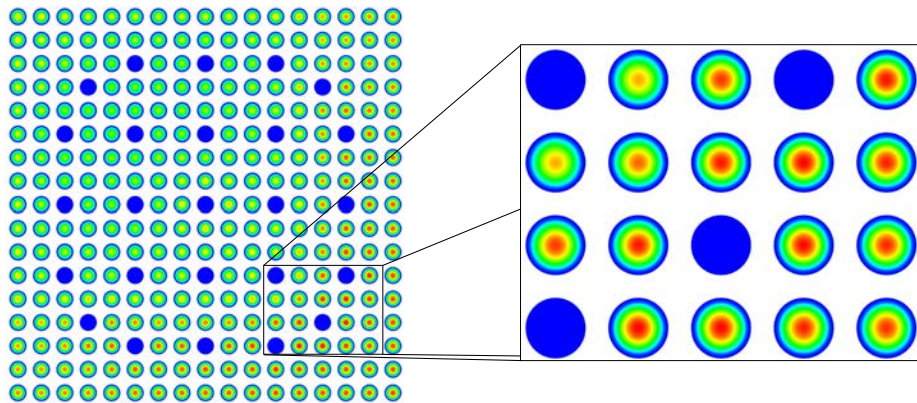

Fuel temperature distribution – OpenMC/BISON

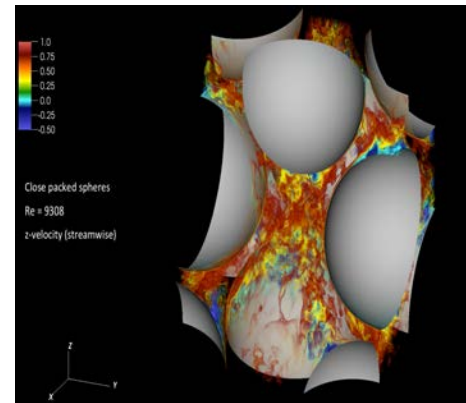

Turbulent Heat Flux – Nek5000/BISON

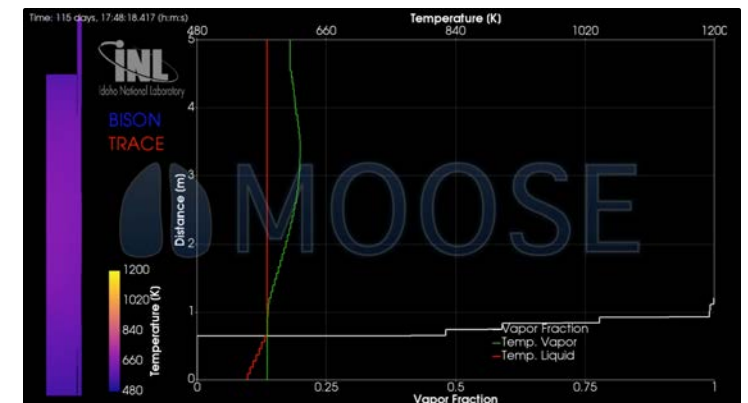

SBO Simulation TRACE - BISON

Preliminary Development: *Single and two-phase 3D subchannel flow capability*

- Initial single-phase development at MIT, Kord Smith, Ben Forget, and Sterling Harper. Improved CASMO/SIMULATE (Studsvik) approach.

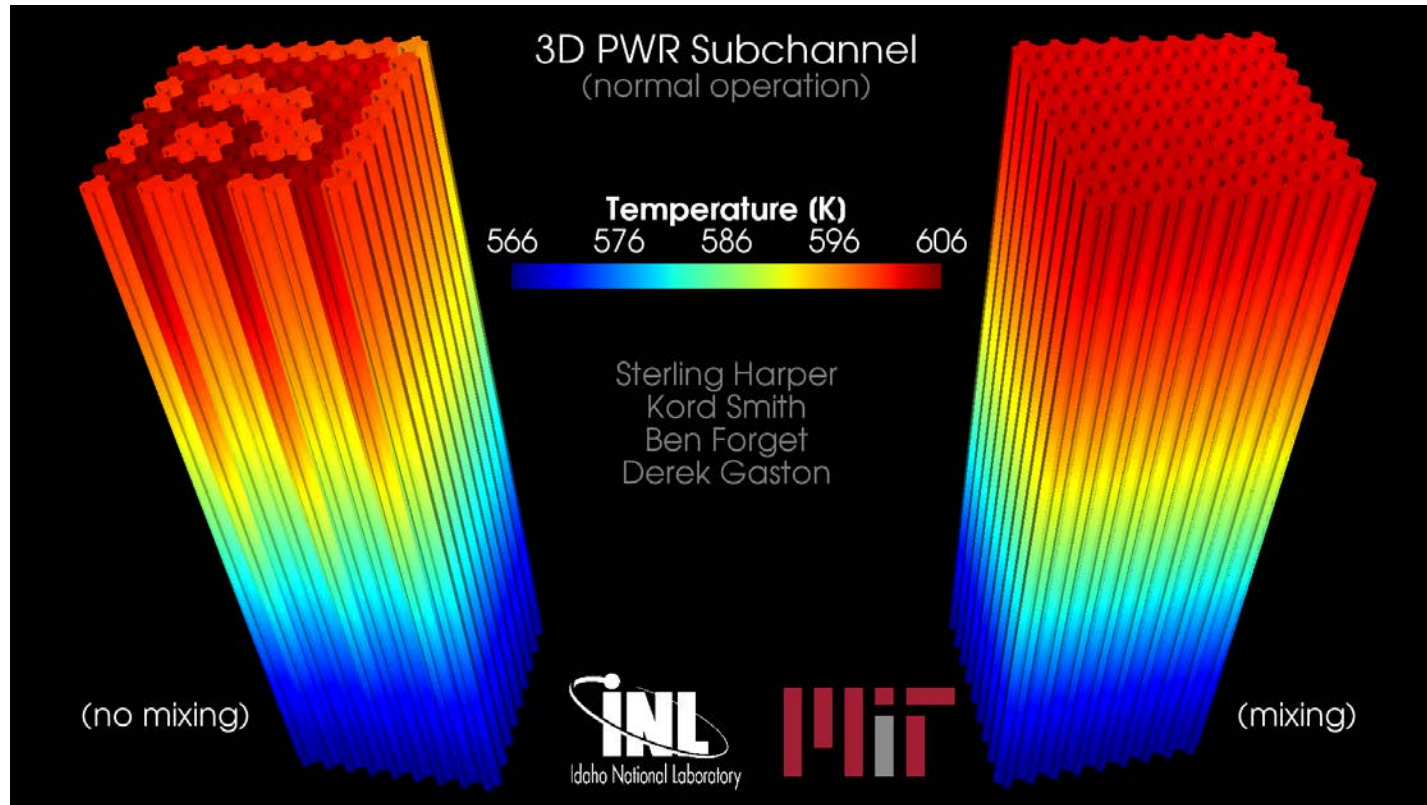

Without and with subchannel mass and energy exchange terms.

- Closure relations development and validation for LWR 3D flow assemblies will be conducted at Texas A&M.
- Different spacer configurations will be considered in the experiments.
- Algorithmic development of 7-equation two-phase 3D subchannel conducted at INL, MIT, and Texas A&M (PhD student).
- Coupled to RELAP-7 for balance of plant.

Preliminary Development: *Single and two-phase 3D subchannel flow (cont'd)*

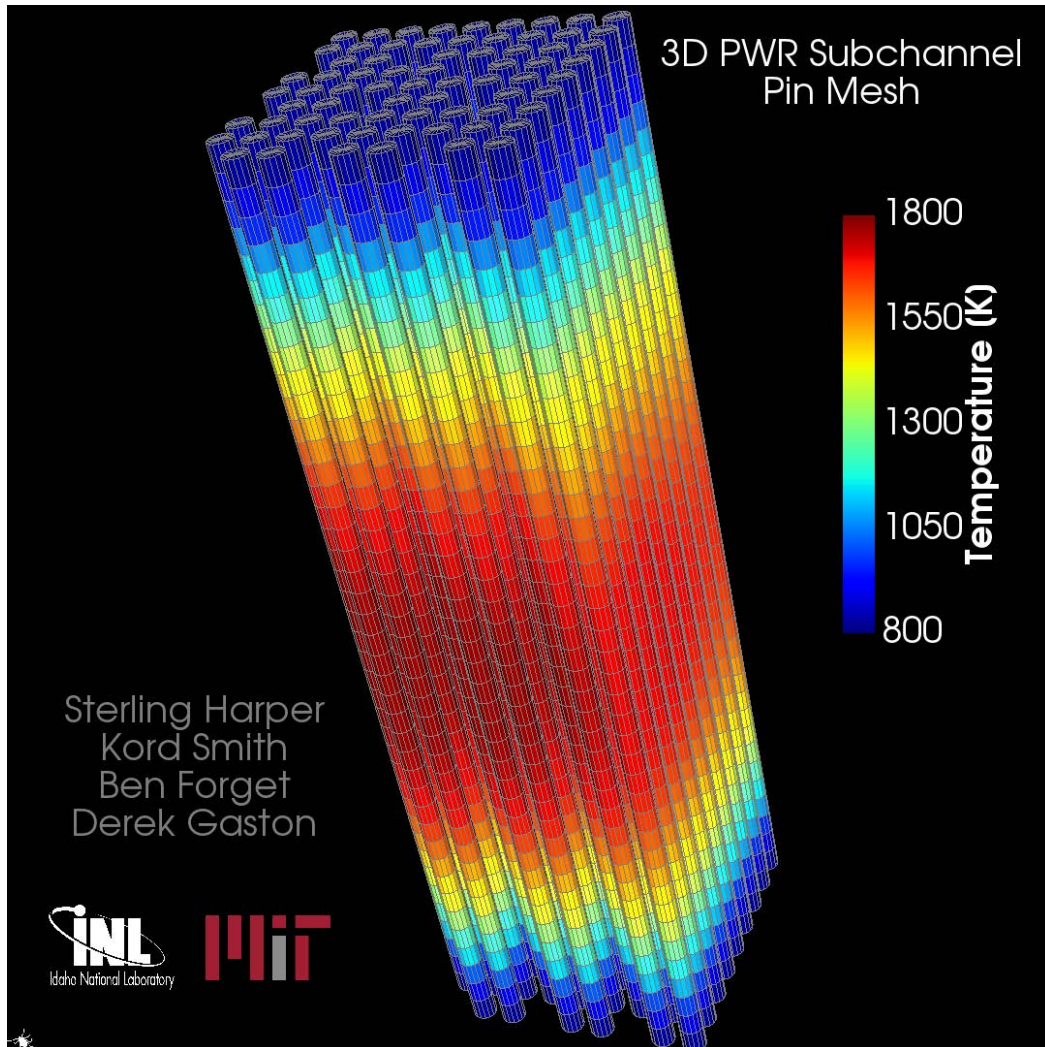

3D Subchannel Development Goals:

- Coupled to RELAP-7 through “MultiApps and Transfersd”
- No traditional pin heating models. 3D subchannel formulations tightly coupled to BISON.
- BISON allows realistic fuels performance to be included in core calculations.
- Geometry agnostic. Capable of hexagonal fuel assemblies for SFR analysis, including VTR.
- MOOSE implicit calculation with MAMMOTH - Rattlesnake allow for detailed core burnup over life of fuel.
- Monte Carlo applications with Serpent, MC21 and MCNP will also be supported.
- Will be easily coupled to CASL’s MPACT and MAMBA CRUD codes.

Fuel pin temperatures with BISON

In the Future, Multi-scale, Multi-dimensional Multi-physics, Nuclear Power Plant Systems Analysis

MAMMOTH (Rattlesnake)
 MCNP/Serpent/MC21
 CFD informed
 MAMBA
 Hognose/Yellojacket
 BISON/Marmot
 Grizzly (RPV CIs)
 Pronghorn (3D SC)

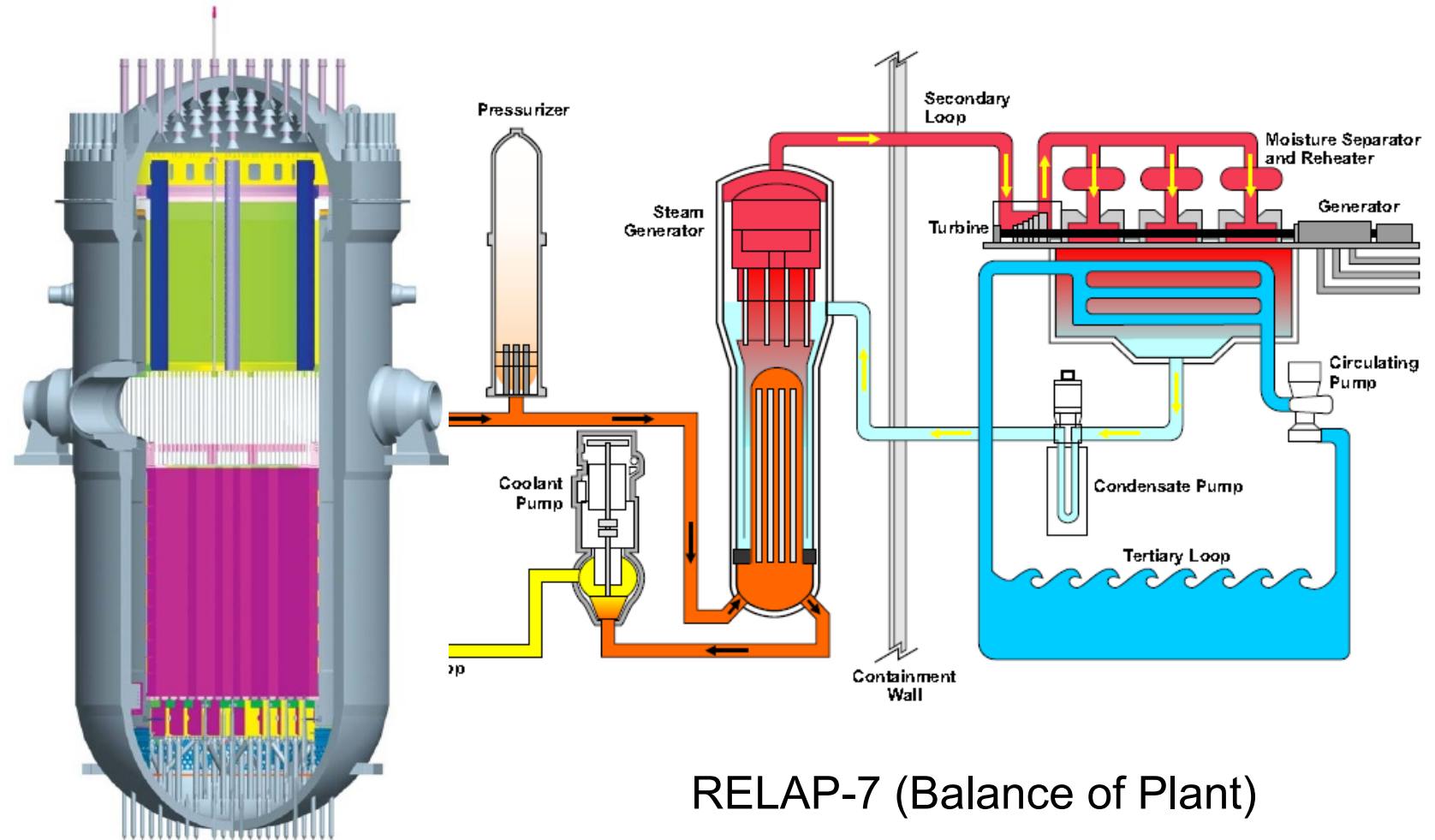

RELAP-7 (Balance of Plant)

Summary of “what RELAP-7 can do now”

Current RELAP-7 Capabilities

- **Flow Models:**
 - Single-Phase Thermal Fluids Model – conservative compressible form (Hyperbolic)
 - 7-Equation, Two-Phase Thermal Fluids Model – two phasic pressures, conservative compressible form (Hyperbolic)
 - Noncondensable gas – Steam + one noncondensable gas component (N₂ and He)
- **Reactor Kinetics Model:**
 - Point Kinetics Model
 - Fission Product Decay Model
 - Actinide Decay Model
 - Reactivity Feedback Model
- **Spline Based Table Look-up Method with IAPWS-95 Equation of State for Steam and Water**
- **Component Models:**
 - 2D Heat Structure
 - Pipe
 - Core Channel (Pipe with 2D Heat Structure)
 - Single-Phase Junction, Single-Phase Volume Junction
 - Pump, Turbine, Wet Well, Separator-Dryer, etc.

RELAP-7 Closures are nearly identical to those in TRACE v5.0

- RELAP – 7 can utilize the TRACE closure relations and flow regime maps.
 - Wall Friction
 - Interfacial Area
 - Interfacial Friction
 - Interfacial heat transfer
 - Wall heat transfer and boiling
- Flow Regime Maps are used for Pre and Post CHF flow.
 - 11 parameters needed to determine which flow regimes are relevant
(alpha_vapor, mass_flux, superficial velocity, pipe inclination, T_chf, T_min, etc.)
- Areas still under development
 - Post-CHF quenching – TRACE requires a neighboring cell to quench first.
 - Non-condensable closure relation corrections have not yet been implemented.
 - Specialized models such as Counter-Current Flow Limiters (CCFL) are yet to be implemented

Closure Verification

- Primary verification is by means of point by point verification comparison between TRACE (5.1150) and RELAP-7
 - We have a special version of TRACE modified to allow direct calling of the closure relations using RELAP-7 base flow properties for all non-iterative closures.
 - For Iterative closures (Post-CHF), the TRACE IAPWS 95 equation of state is still used; variations in properties are small but present.
 - A thermal-hydraulic state point in each different code branch for TRACE is compared with the same state in RELAP-7:
 - E.g. Wall friction: Two-Phase Annular Mist (wall film thickness greater than 25 μm):
 - Press. 8.246E5 Pa, fluid at T_{sat} 444.81 K, alpha vapor 0.981, velocity 25.52m/s, H_d 1.168 cm
 - RELAP-7 Props: ρ_l 895.747820 kg/m³, ρ_v 4.28225293 kg/m³ vis_liq =1.58133E-4 Pa-s vis_vap 1.47012E-5 Pa-s surface tension 0.0440404 N/m
 - TRACE wall friction: 3.73433384E-3 RELAP-7: 3.73433595E-3 fractional error: 5.6E-7
Typical of all non iterative closures
 - Iterative Post-CHF closures typically are now $\sim 5\text{E-}5$. We believe the errors are principally due to differences in properties used and order of operations.
- Further verification is in progress using simple test cases.

The next three years!

FY-2019 RELAP-7 Milestones

- Develop an explicit time integration scheme for RELAP-7 implementation on arbitrary Runge Kutta approach.
- Implement rDG spatial discretization for implicit time discretization for two-phase flow for use in RELAP-7, SAM and Sockeye.
- Decouple the component system from RELAP-7. The component system can then be used by SAM and Sockeye. Any fixes and improvements made to the component system can then be propagated to the other applications.
- Develop Thermo-transport properties and equation of state for Sodium, Potassium and Sodium and Potassium mixtures (NaK) for Sockeye, SAM, Pronghorn.
- Implement Open-Air Brayton Cycle for Advanced Reactor Concepts.
- Implement Closed Brayton Cycle using Supercritical CO₂ for Advanced Reactor Concepts.

FY-2019 RELAP-7 Milestones (cont'd)

SPECIAL PURPOSE REACTOR

OPEN-AIR BRAYTON CYCLE

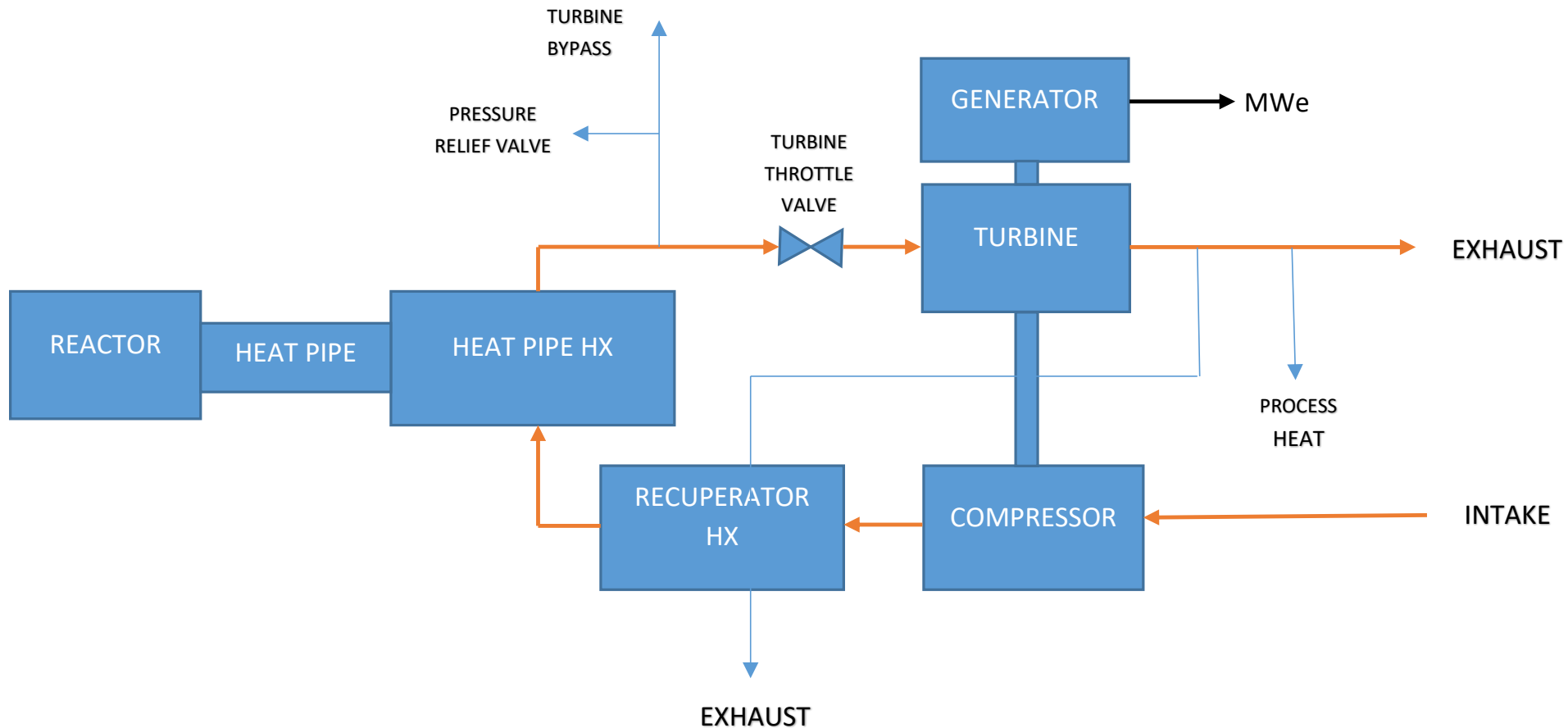

FY-2019 RELAP-7 Milestones (cont'd)

SPECIAL PURPOSE REACTOR

CLOSED-CYCLE BRAYTON USING SUPERCRITICAL CO₂

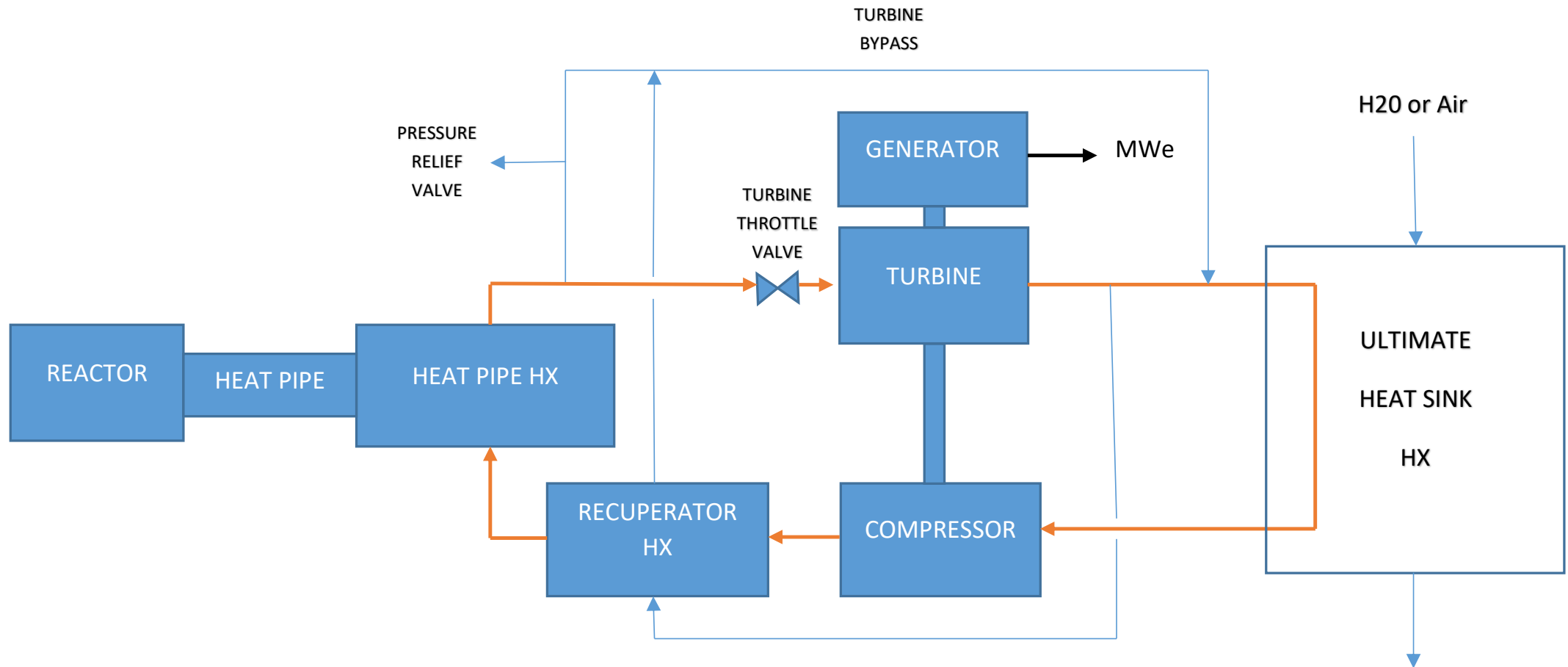

The Future: Major RELAP-7 Capability Development Tasks

- Complete integration of TRACE closure relationships with IAPWS steam/water properties with extensive V&V.
- Implement a MOOSE-based Best Estimate Plus Uncertainty (BEPU) capability for uncertainty analysis/
- Improved LWR components (1D-2D downcomer, 1D pressurizer, various steam generator designs) to provide improved water level tracking and LOCA temporal accuracy.
- Tightly coupled multiphysics fuels performance and reactor physics (NEAMS and CASL core simulator applications) for improved design and safety analysis.
- Integrated single and two-phase 3D subchannel, tightly coupled to 2D (r-z) and 3D fuels performance capability for improved design and safety analysis.
- Conduct experiments designed to measure two-pressure field.
- Include multi-component non-condensable gas model to the 7-Equation two-phase flow model

The Future: Major RELAP-7 Capability Development Tasks (cont'd)

- Oxide species transport models for CRUD and Boron deposition analysis in CASL (MAMBA and Vulture).
- Include multi-component non-condensable gas model to the 7-Equation two-phase flow model.
- Input checking and output diagnosis.
- Continued verification of numerical methods, governing equations, closure relations, and plant components. Temporal and spatial grid convergence, MMS, single-phase analytical solutions, etc.
- Verification of numerical methods, governing equations, closure relations, and plant components. Temporal and spatial grid convergence, MMS, single-phase analytical solutions, etc.
- Validation of selected integral effects tests, Edward's Pipe, Cannon and Super Cannon, ... and non-vender specific reactor plants, such as LOFT.

Questions?

Validation Experiments

7-Equation Two-Phase Flow Model: Interfacial mass transfer & interfacial heat transfer, gravity force, wall and interphase viscous drag, and simple wall heat transfer

$$\frac{\partial \alpha_l A}{\partial t} + u_{\text{int}} A \frac{\partial \alpha_l}{\partial x} = A \mu (p_l - p_g) - \frac{\Gamma A_{\text{int}} A}{\rho_{\text{int}}} \quad (\text{or } \alpha_g = 1 - \alpha_l)$$

$$\frac{\partial \alpha_l \rho_l A}{\partial t} + \frac{\partial \alpha_l \rho_l u_l A}{\partial x} = -\Gamma A_{\text{int}} A$$

$$\begin{aligned} \frac{\partial \alpha_l \rho_l u_l A}{\partial t} + \frac{\partial \alpha_l A (\rho_l u_l^2 + p_l)}{\partial x} &= p_{\text{int}} A \frac{\partial \alpha_l}{\partial x} + p_l \alpha_l \frac{\partial A}{\partial x} + A \lambda (u_g - u_l) \\ &\quad - \Gamma A_{\text{int}} u_{\text{int}} A - f_l \alpha_l \rho_l u_l^2 (\pi A)^{\frac{1}{2}} \\ &\quad - f_l' \frac{1}{2} \rho_l (u_l - u_{\text{int}})^2 A_{\text{int}} A + \alpha_l \rho_l \vec{g} \cdot \hat{n}_{\text{axis}} A \end{aligned}$$

$$\begin{aligned} \frac{\partial \alpha_l \rho_l E_l A}{\partial t} + \frac{\partial \alpha_l u_l A (\rho_l E_l + p_l)}{\partial x} &= p_{\text{int}} u_{\text{int}} A \frac{\partial \alpha_l}{\partial x} \\ &\quad - \bar{p}_{\text{int}} A \mu (p_l - p_g) + \bar{u}_{\text{int}} A \lambda (u_g - u_l) \\ &\quad + \Gamma A_{\text{int}} \left(\frac{p_{\text{int}}}{\rho_{\text{int}}} - H_{l \text{int}} \right) A \\ &\quad + A_{\text{int}} h_{Tl} (T_{\text{int}} - T_l) A \\ &\quad + \alpha_l h_{lw} (T_w - T_l) \left[4\pi A + \left(\frac{\partial A}{\partial x} \right)^2 \right]^{\frac{1}{2}} \\ &\quad + \alpha_l \rho_l u_l \vec{g} \cdot \hat{n}_{\text{axis}} A \end{aligned}$$

liquid

$$\frac{\partial \alpha_g A}{\partial t} + u_{\text{int}} A \frac{\partial \alpha_g}{\partial x} = A \mu (p_g - p_l) + \frac{\Gamma A_{\text{int}} A}{\rho_{\text{int}}} \quad (\text{or } \alpha_g = 1 - \alpha_l)$$

$$\frac{\partial \alpha_g \rho_g A}{\partial t} + \frac{\partial \alpha_g \rho_g u_g A}{\partial x} = \Gamma A_{\text{int}} A$$

$$\begin{aligned} \frac{\partial \alpha_g \rho_g u_g A}{\partial t} + \frac{\partial \alpha_g A (\rho_g u_g^2 + p_g)}{\partial x} &= p_{\text{int}} A \frac{\partial \alpha_g}{\partial x} + p_g \alpha_g \frac{\partial A}{\partial x} + A \lambda (u_l - u_g) \\ &\quad + \Gamma A_{\text{int}} u_{\text{int}} A - f_g \alpha_g \rho_g u_g^2 (\pi A)^{\frac{1}{2}} \\ &\quad - f_g' \frac{1}{2} \rho_g (u_g - u_{\text{int}})^2 A_{\text{int}} A + \alpha_g \rho_g \vec{g} \cdot \hat{n}_{\text{axis}} A \end{aligned}$$

$$\begin{aligned} \frac{\partial \alpha_g \rho_g E_g A}{\partial t} + \frac{\partial \alpha_g u_g A (\rho_g E_g + p_g)}{\partial x} &= p_{\text{int}} u_{\text{int}} A \frac{\partial \alpha_g}{\partial x} \\ &\quad - \bar{p}_{\text{int}} A \mu (p_g - p_l) + \bar{u}_{\text{int}} A \lambda (u_l - u_g) \\ &\quad - \Gamma A_{\text{int}} \left(\frac{p_{\text{int}}}{\rho_{\text{int}}} - H_{g \text{int}} \right) A \\ &\quad + A_{\text{int}} h_{Tg} (T_{\text{int}} - T_g) A \\ &\quad + \alpha_g h_{gw} (T_w - T_g) \left[4\pi A + \left(\frac{\partial A}{\partial x} \right)^2 \right]^{\frac{1}{2}} \\ &\quad + \alpha_g \rho_g u_g \vec{g} \cdot \hat{n}_{\text{axis}} A \end{aligned}$$

vapor

RELAP-7 Validation Experiment: Caleb Brooks, University of Illinois, Urbana-Champaign, Department of Nuclear, Plasma, and Radiological Engineering

Objective: Measure the pressure relaxation

- Constant area, liquid volume fraction evolution equation for constant area, non-condensable gas-phase:

$$\frac{\partial \alpha_l}{\partial t} + u_{int} \frac{\partial \alpha_l}{\partial x} = \mu(p_l - p_g) + \Gamma$$

- α_l : liquid fraction
- u_{int} : is interface velocity
- p : is phase pressure
- μ : is pressure relaxation coefficient
- Z : is phase acoustic impedance

$$u_{int} = \bar{u}_{int} + sgn \left(\frac{\partial \alpha_l}{\partial x} \right) \frac{\rho_g + \rho_l}{Z_l + Z_g} \quad \bar{u}_{int} = \frac{Z_l u_l + Z_g u_g}{Z_l + Z_g}$$

- The mechanical relaxation coefficients are:

$$\mu = \frac{A_{int}}{Z_l + Z_g} \quad \lambda = \frac{1}{2} \mu Z_l Z_g$$

- To obtain *data* of the pressure relaxation, must simultaneously measure:
 - Both phase pressures
 - Interface position
 - Liquid volume fraction
 - Both phase velocities
- No known datasets measure all parameters simultaneously
 - Very difficult under most flow conditions and geometries
 - Difference in phase pressures are in denominator
 - pressure relaxation coefficient is a function of the local phasic sound speeds and phasic topology.
 - Significant uncertainty propagation requires very accurate instrumentation

- **Conclusion: Rapid blowdown experiment of a stratified pipe**

RELAP-7 Validation Experiment: Caleb Brooks, University of Illinois, Urbana-Champaign, Department of Nuclear, Plasma, and Radiological Engineering

Facility

- 5m tall pipe with viewport at initial stratified water level.
- Surge line connects pipe to large charging tank.
- Pressure (up to 150psi) is initialized in system.
- Fast-active 3-way valve triggers depressurization of the charging tank, blowdown of stratified pipe.

Experiment Overview

1. 3-way actuated valve initiates blowdown.
2. Fast-acting piezo-resistive pressure transducers detect pressure wave.
3. Pressure across stratified liquid level is measured in time.
4. High speed imaging tracks interface.
5. PIV measures both phase velocities near interface.
6. Surge line flowrate measured by flow meter.

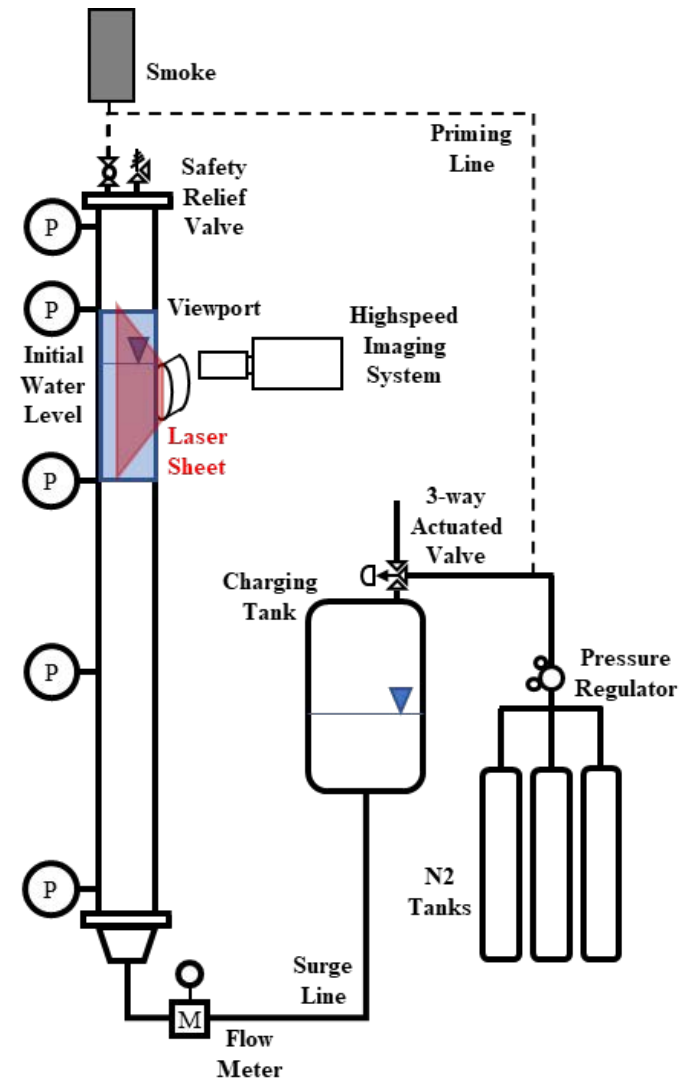

NEUP RELAP-7 Validation Experiments for 7-Equation Model: Philippe M. Bardet, Mechanical and Aerospace Engineering, The George Washington University

Validate the pressure relaxation term of seven-equation model:

- Measure non-equilibrium processes with non-intrusive, high-speed laser spectroscopy
- 2 experiments under development: Laser steam explosion & Water hammer.
 - Canonical, repeatable, & modular
 - Designed around deployment of laser spectroscopy systems
- 3D multi-phase direct simulations will complement the experiment
 - Extends dimensionality
 - Allows to refine experimental parameters/diagnostics

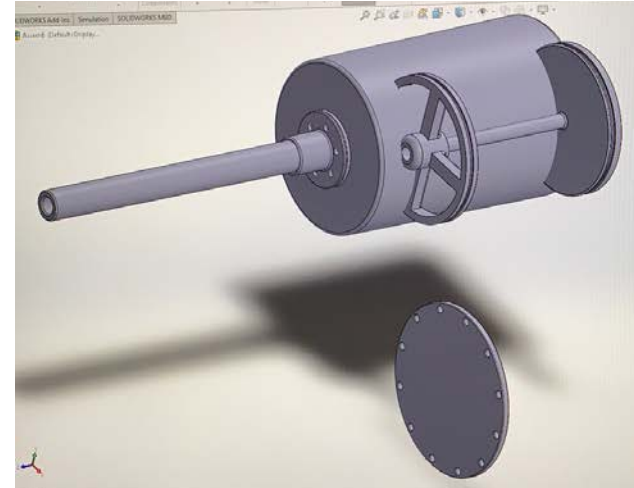

Water hammer: Rich's Pipe air-cannon (under design) to accelerate water filled pipe before impact

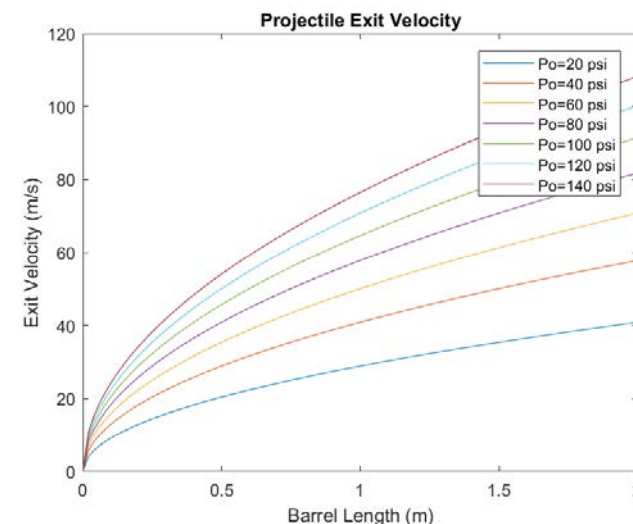

Terminal velocity of 2 kg projectile as function of barrel pressure and barrel length

NEUP RELAP-7 Validation Experiments for 7-Equation Model: Philippe M. Bardet, Mechanical and Aerospace Engineering, The George Washington University

Multi-physics laser diagnostics to probe non-equilibrium processes:

- Laser diagnostics for validating pressure relaxation of seven-equation model
 - Tight control of resolution and uncertainties
 - First-principled, spectroscopy based
 - Diagnostics are custom designed (not relying on commercial vendor for data analysis/processing)
 - Velocimetry in steam and water with molecular probes: Molecular Tagging Velocimetry – MTV.
 - No seeding issues, particles lag, etc.
 - Pressure in gas and liquid
 - Laser spectroscopy based on rotational and vibrational temperature measurements



Laser system for MTV in steam

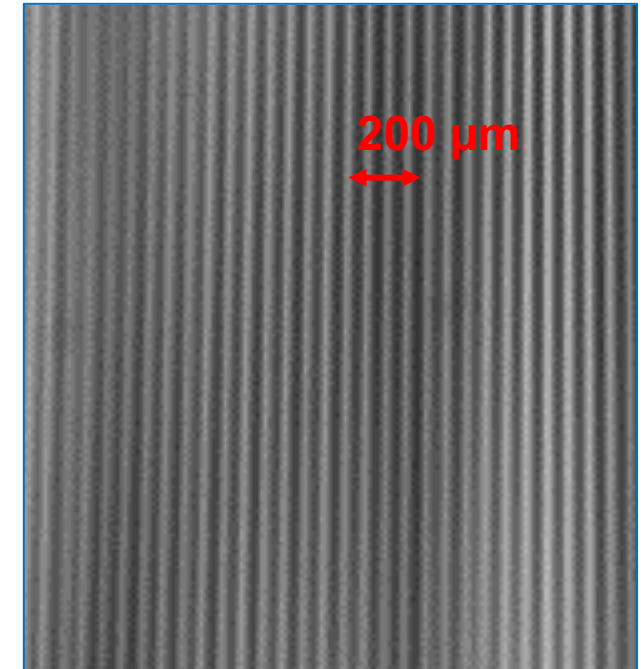

Fine MTV pattern for micro-scale velocimetry: ~ 10 μm Ø beamlets

Validation of 3D Subchannel: Yassin A. Hassan, Department of Nuclear Engineering, Texas A&M

The purpose of the fuel assembly (5x5) investigation is to study the interactions between subchannels and provide data to validate RELAP-7.

- High resolution measurement techniques will be utilized to acquire high fidelity data of full field velocity and temperature.
- Accurate closure relations will be developed and implemented in RELAP-7.
- In addition the following data will be acquired for:
 - Pressure Drop Measurements
 - Subchannel Mixing
 - High Resolution Velocity components and uncertainty quantification
 - Two-Phase Flow Measurements

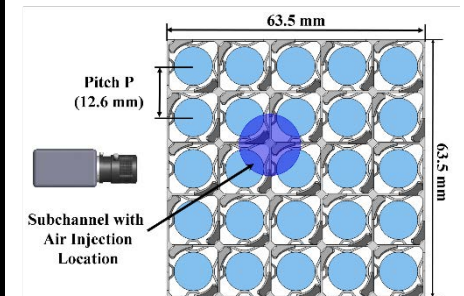

Re = 14,000 Air Flow Rate: 0.28 l/m

Experimental Facility Overview: High resolution Single and Two-Phase Flow Measurements

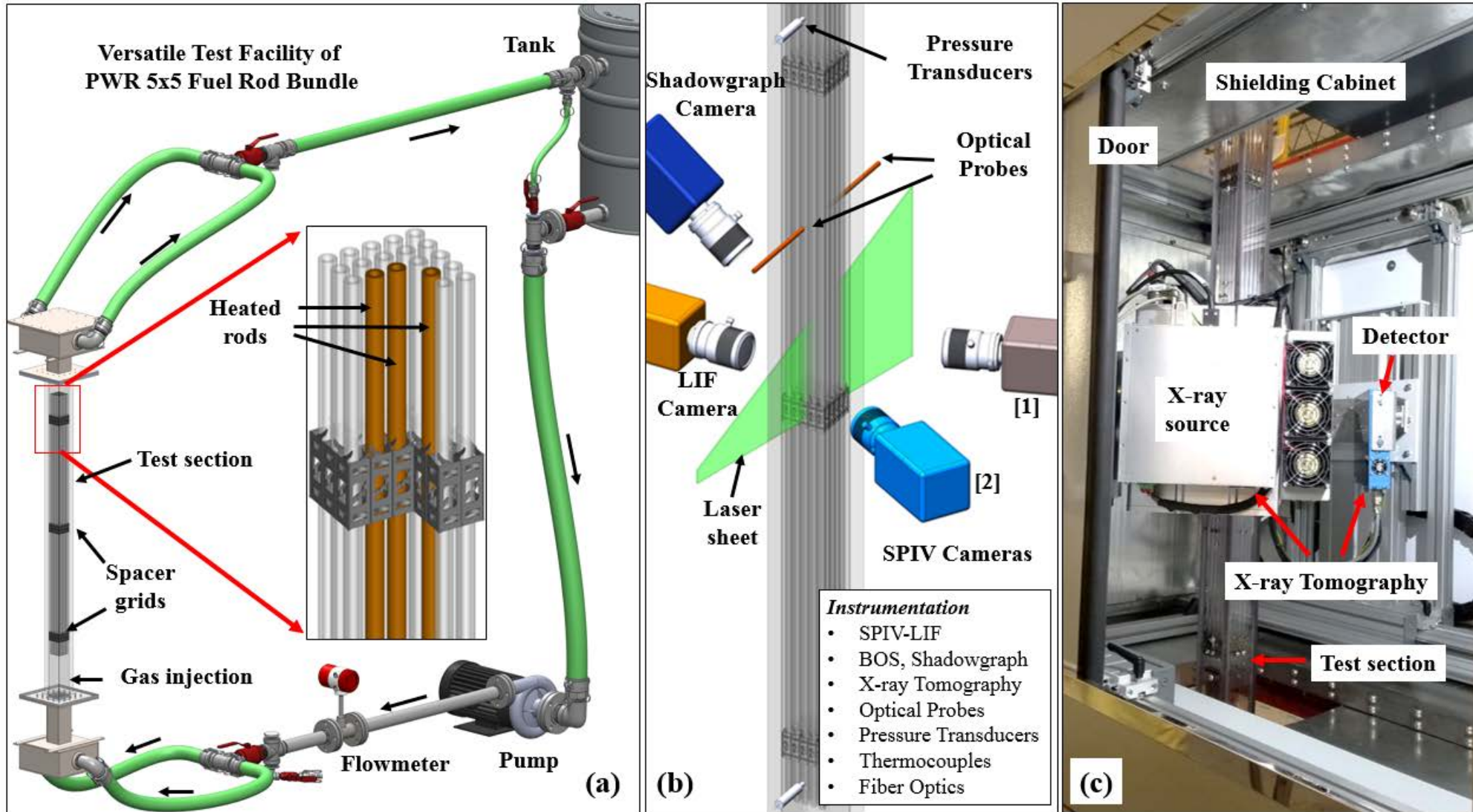

Lateral Velocity Components Measurement

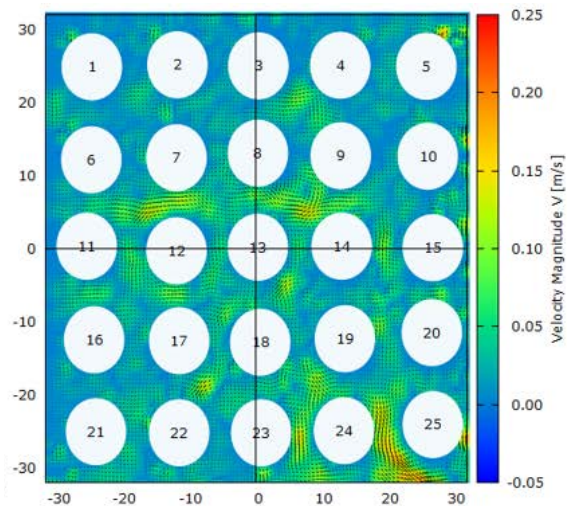

Full view velocity measurements of 5x5 rod bundle

Z = 254.0 mm

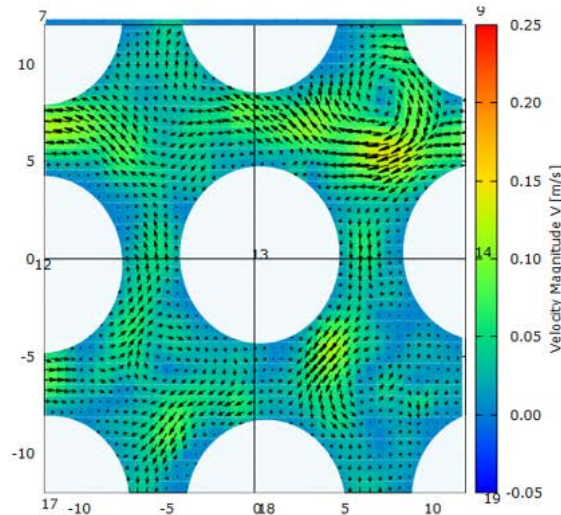

central sub-channels

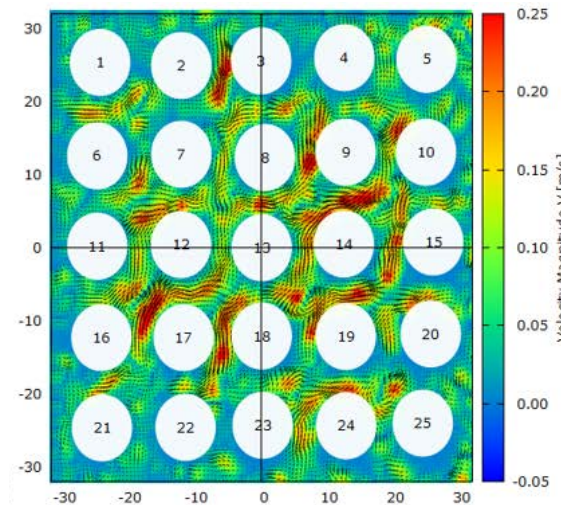

Full view velocity measurements of 5x5 rod bundle

Z = 36.567 mm

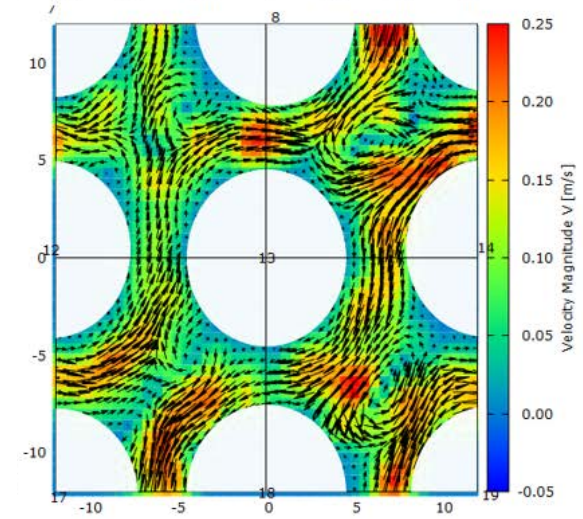

central sub-channels

- The test bundle will provide experimental data of the turbulent interchange component of the lateral flow between subchannels.
- High resolution experimental data produced will support the calibration of subchannel formulations.

High Resolution Void Fraction Measurements

- Simultaneous high-resolution measurements of velocity, void fraction and temperatures to support the calibration and validation of the two lateral flow components of mass, momentum, and energy subchannel interchange.

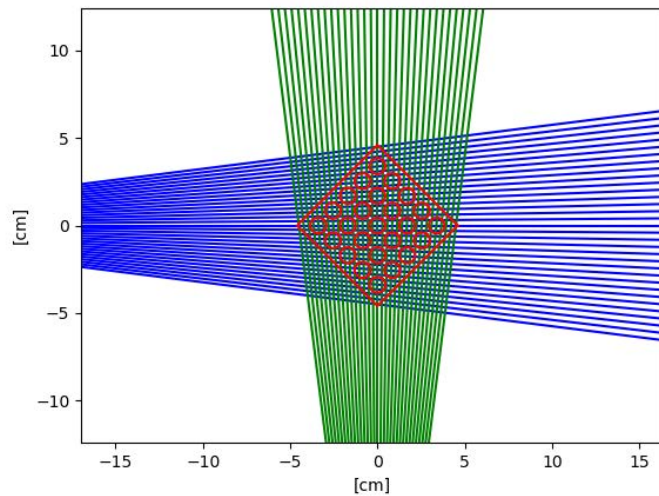

X-Ray Tomography

