

**NUCLEAR ENGINEERING**  
TEXAS A&M UNIVERSITY

**Impact of Pressure Relief Holes  
on Core Coolability for a PWR  
during a Large-Break Loss of  
Coolant Accident with Core  
Blockage using RELAP5-3D**

Rodolfo Vaghetto  
International RELAP5-3D User's Group Meeting  
13-14 August 2015



# Introduction

GSI-191 Background  
Accident Scenario  
Study Motivation

# Introduction



## An aging steam delivery system



The steam conduit that exploded in midtown Manhattan was part of New York City's labyrinth of underground cables, tunnels and pipes – a system implemented more than 100 years ago. Experts believe the age of the city's infrastructure might have been a factor.

- Approximate steam network area
- Steam plant

Technicians use **manholes** to reach the steam pipes to shut them off or make adjustments

Steam vents are used to carry steam above windshield level for visibility purposes.....

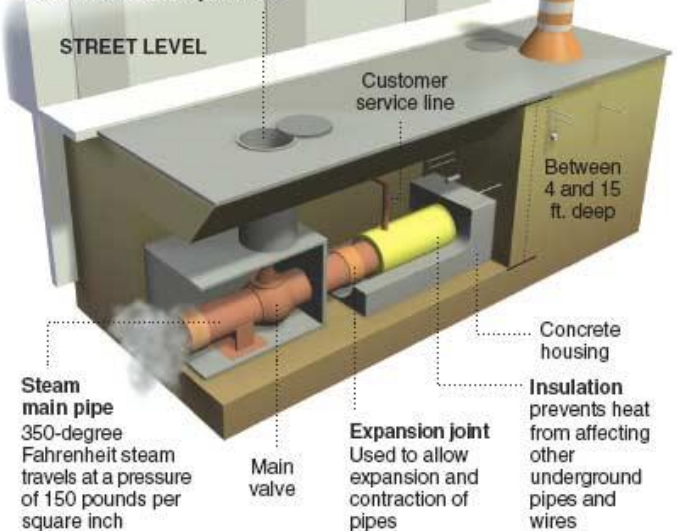

[http://www.nbcnews.com/id/19844481/ns/us\\_news-life/t/aging-ny-pipes-raise-concerns-more-blasts/#.VDX10mddWSo](http://www.nbcnews.com/id/19844481/ns/us_news-life/t/aging-ny-pipes-raise-concerns-more-blasts/#.VDX10mddWSo)



# Introduction (Accident Scenario)

- When the break occurs, high energy jet from the break impinges into surrounding materials other components such that reactor/pipe insulation , producing debris
  - Debris generated could accumulate on strainers and impair pump performance
  - Debris could also bypass sump strainers and enter the primary system
- ECCS Process during a break
  - Coolant is drawn from the RWST (Refueling Water Storage Tank) and pumped into the primary system until the RWST is empty
  - Then pumps recycle water by drawing from the containment sump, cooling it via RHR (Residual Heat Removal) system, and pumping back into primary

# Introduction (Accident Scenario)

1. Break occurs
2. Hot water jet from break creates debris
3. Water & debris drain from break to sump compartment

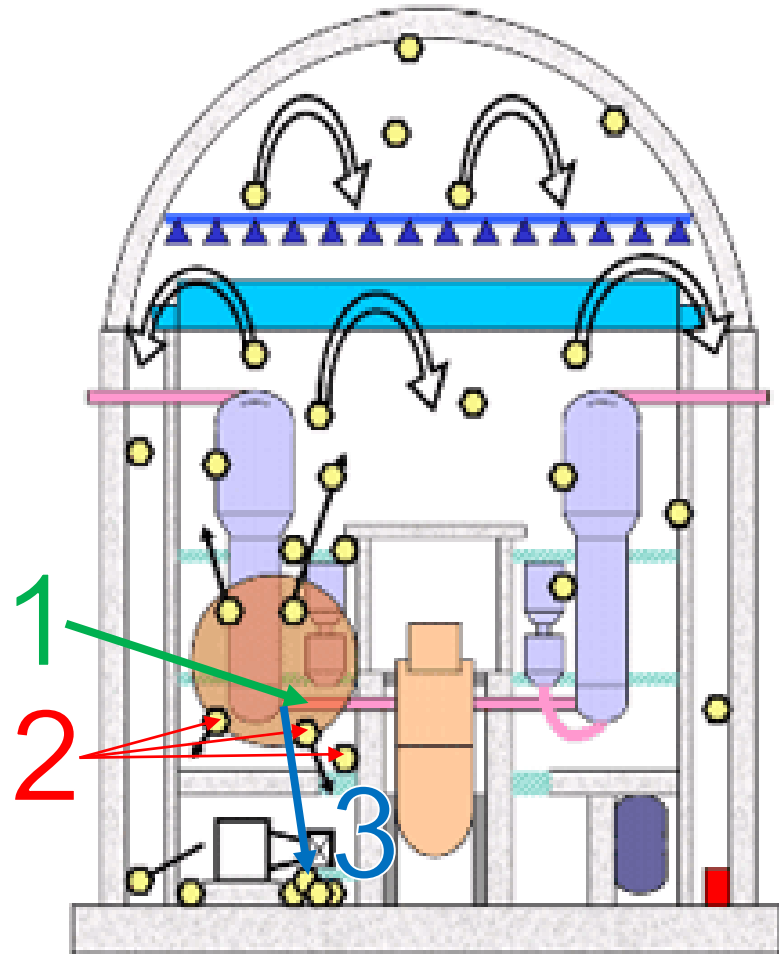

# Introduction (Accident Scenario)

3. Water & debris drain from break to sump compartment
4. ECCS draws water from RWST (Safety Injection Phase), pumping into primary and containment sprays
5. RWST reaches low level, water is now drawn from sump pump (Sump Switchover)

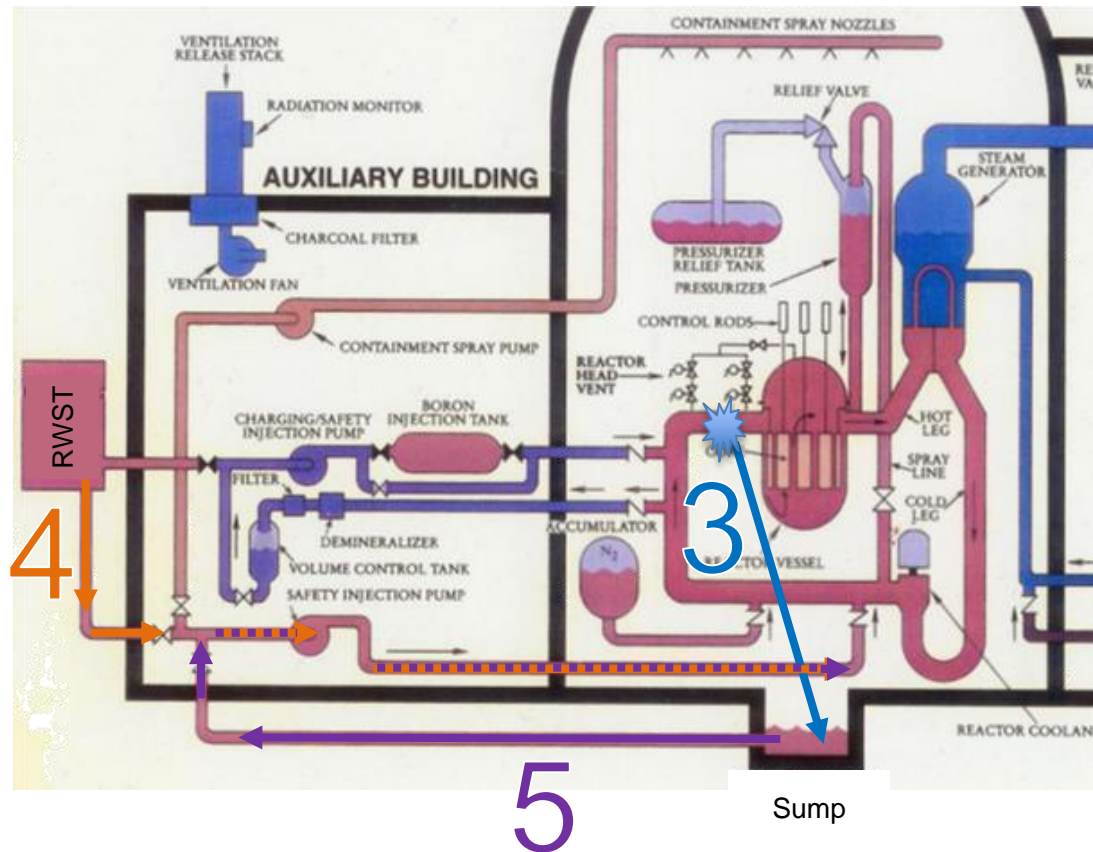

# Introduction (Study Motivation)

- When sump switchover occurs, debris could be drawn into the primary and accumulate at the core inlet
- For this hypothetical scenario, it was assumed full and instantaneous blockage of the core occurred at sump switchover
- In this scenario, coolant can only reach the core through alternative flow paths such as the core bypass or upper head sprays
  - This is realistic due to flow path sizes; the lower core plate/fuel assembly base has much smaller openings than the core bypass

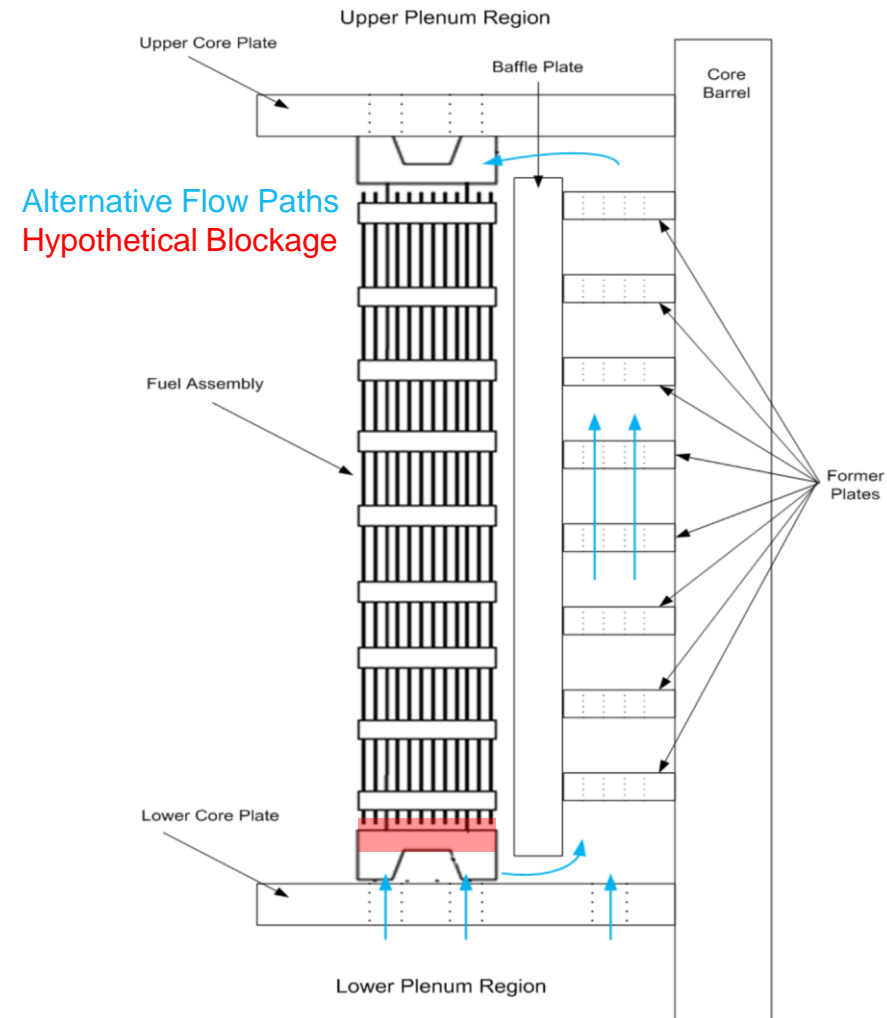

# Previous Study

## Hot Leg Break – Any Size

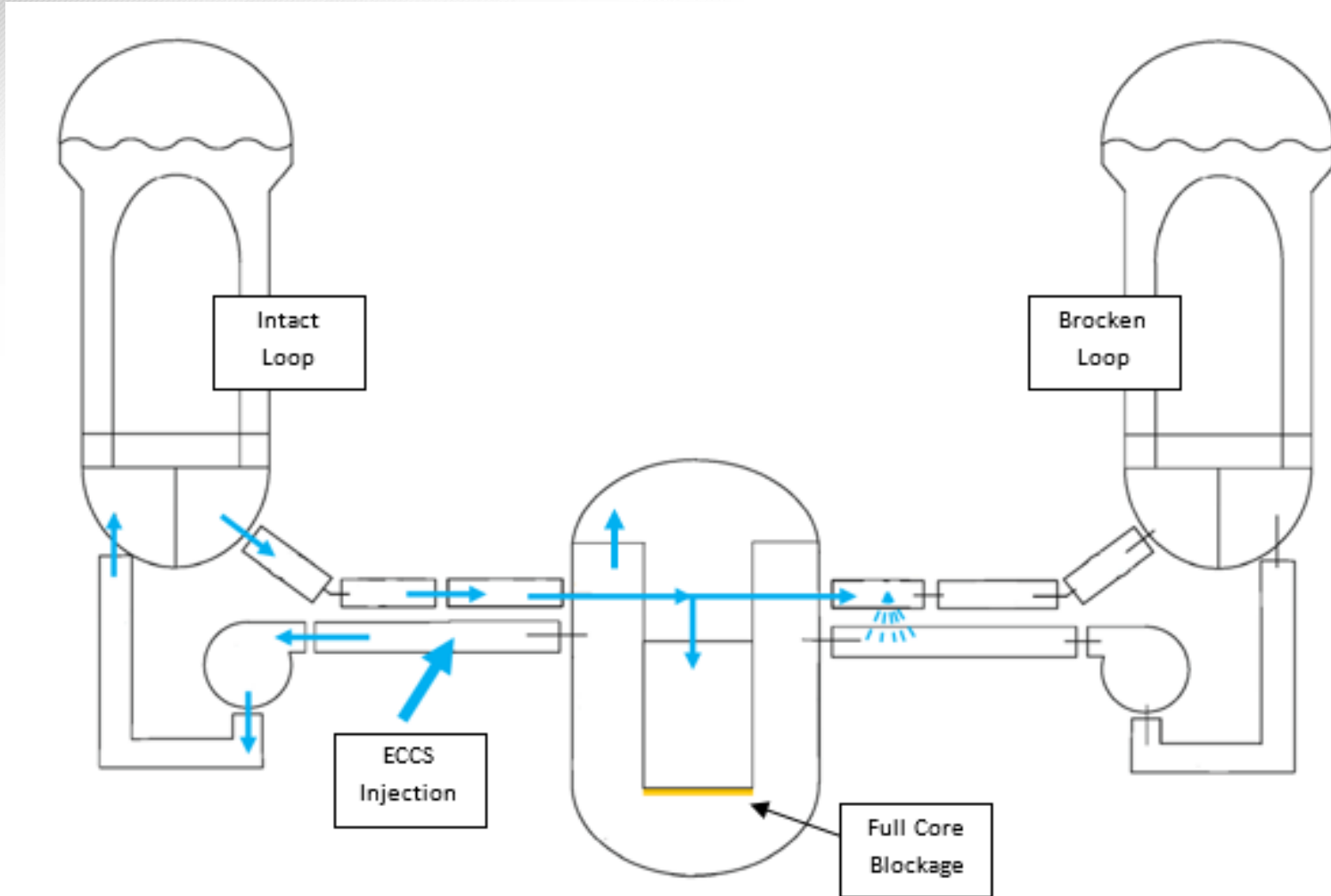



# Previous Study

## Cold Leg Break – Large Size

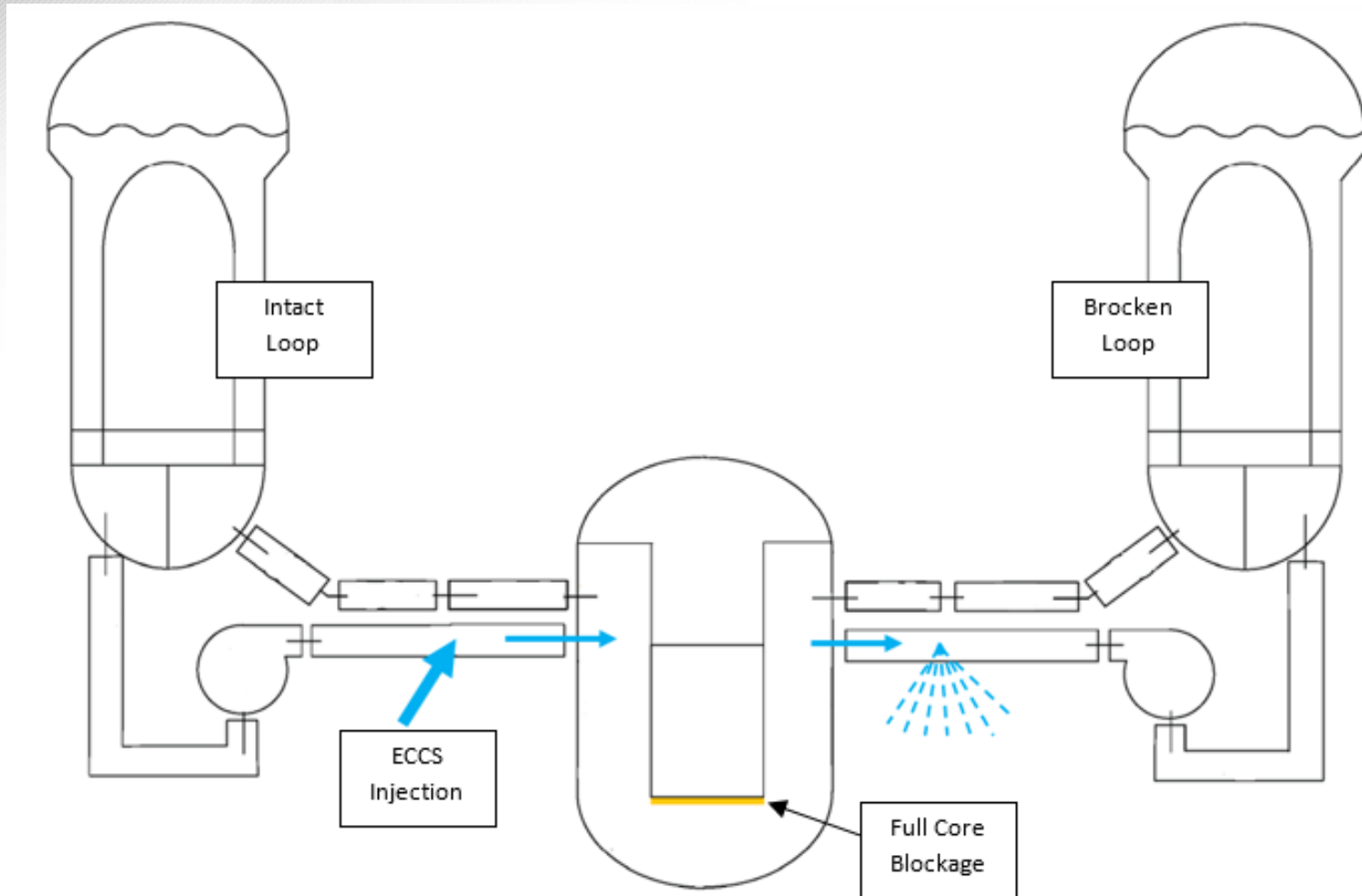

# Introduction (Study Motivation)

## DEG – Cold Leg

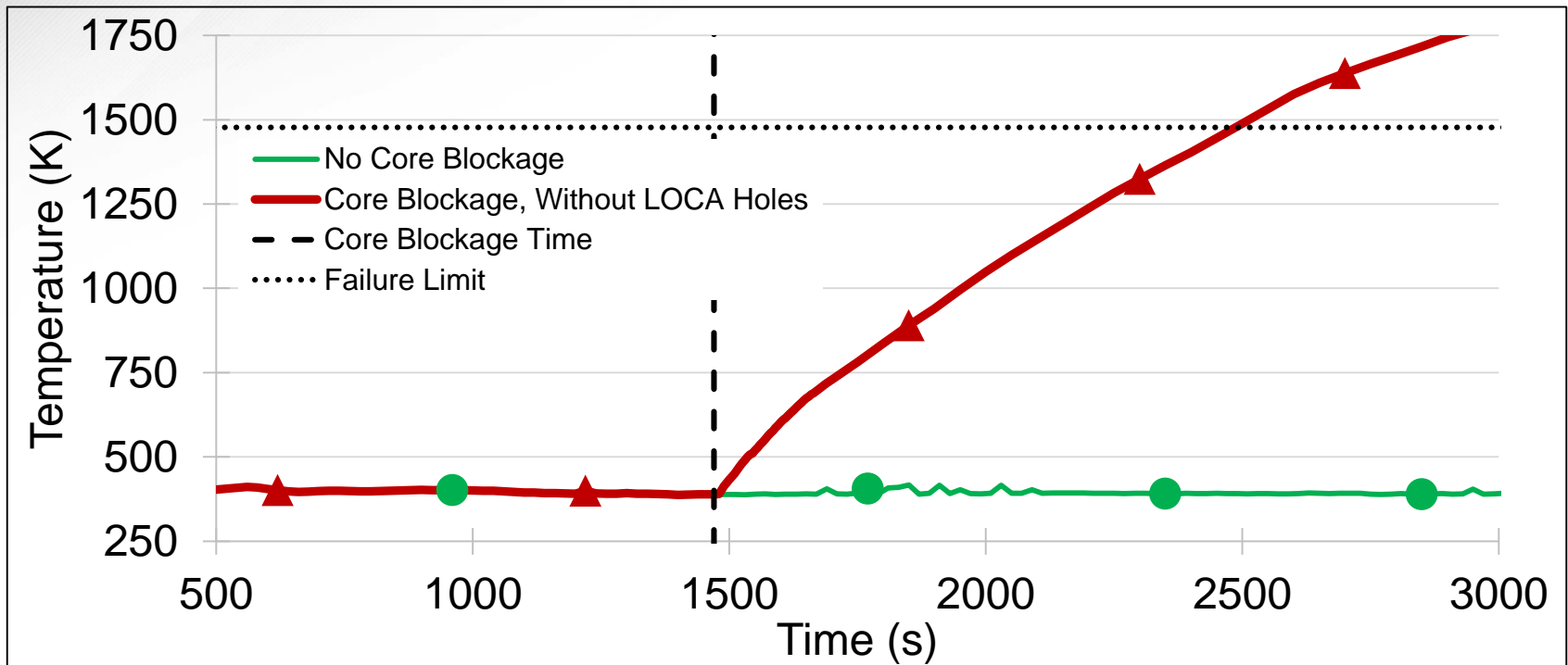

- Alternative Flow Paths to be investigated



# Introduction (Study Motivation)

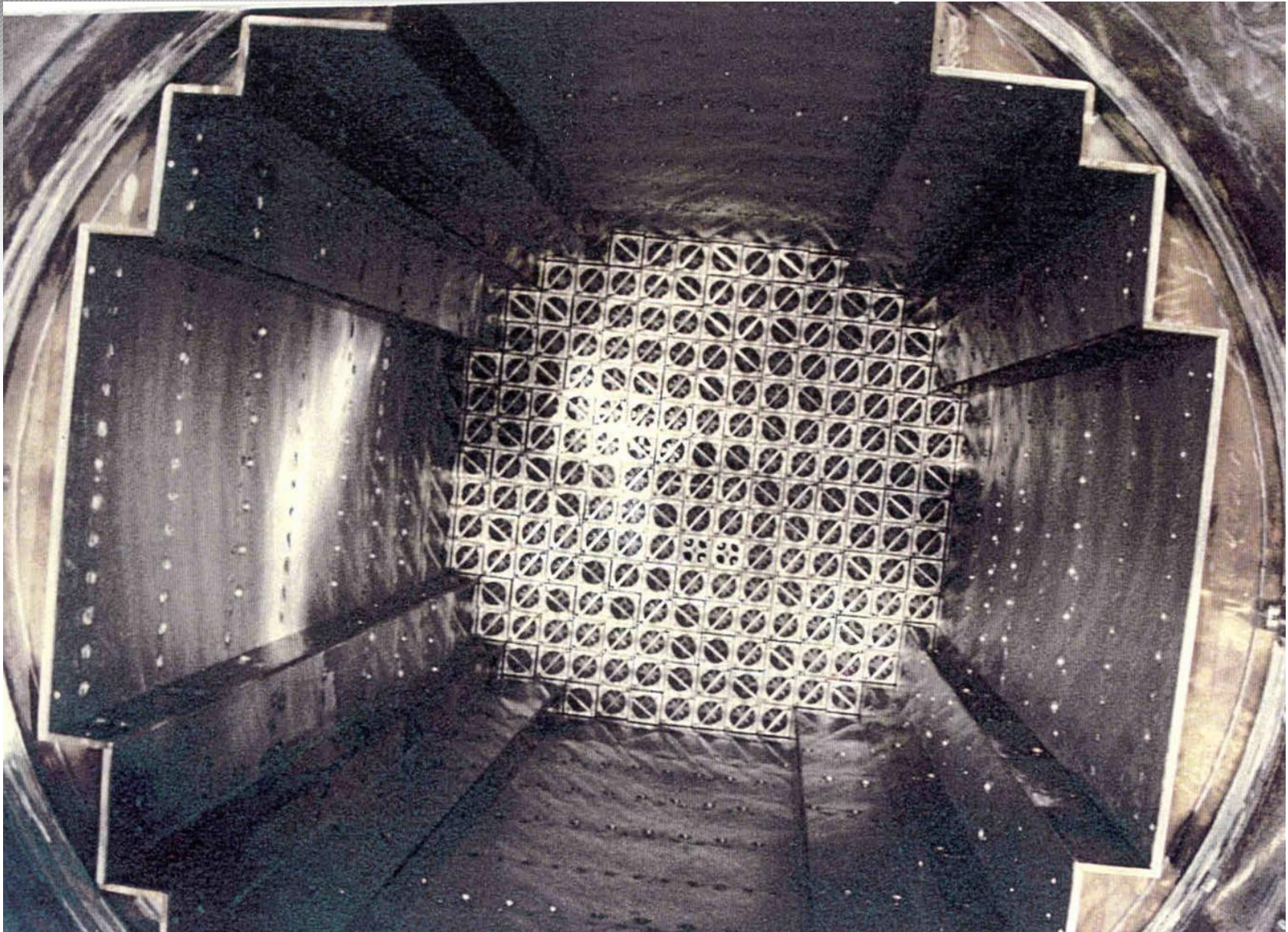

# Introduction (Study Motivation)

- Alternative flow path of interest: Pressure Relief (LOCA) Holes
- LOCA holes consist of a series of holes through Baffle Plate connecting the Core and Core Bypass

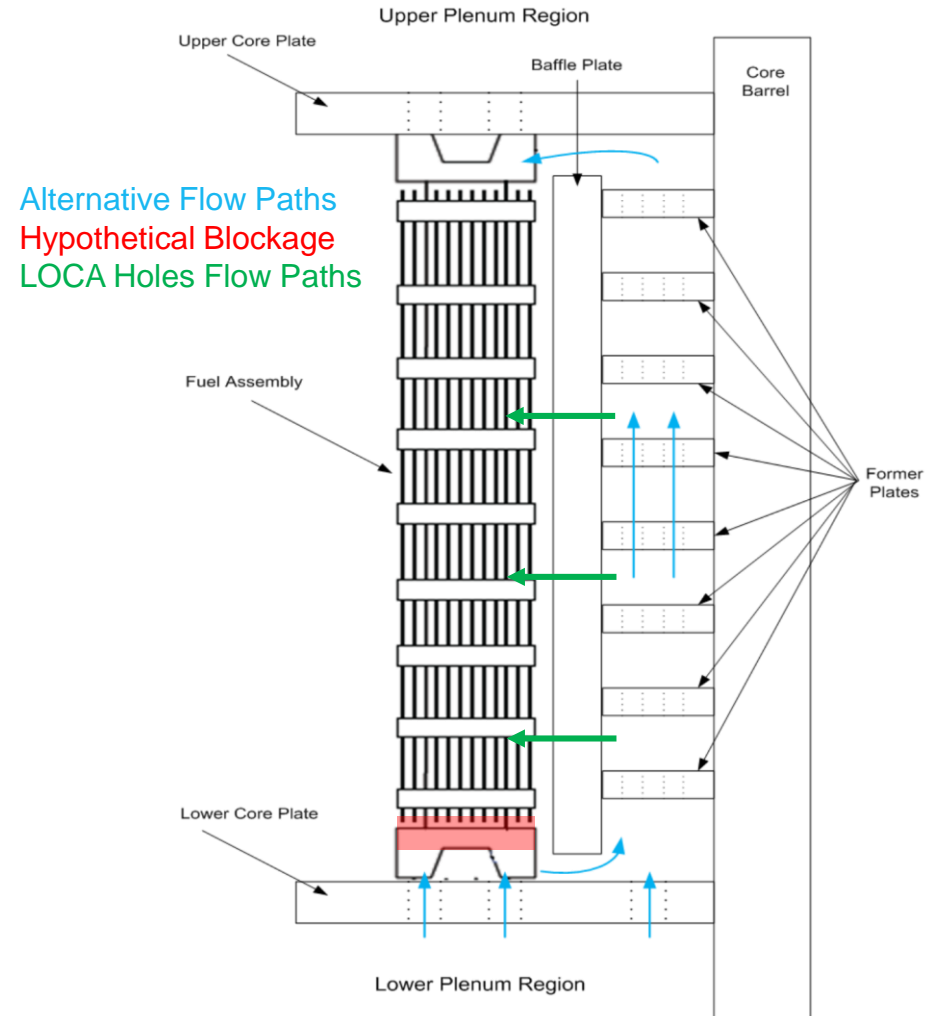



# Input Model Description

Model Without LOCA Holes

ECCS System

Break Simulation

Model With LOCA Holes

Blockage Simulation



# Input Model Description (Model w/o LOCA Holes)

- RELAP5-3D was used for the primary system model
- The model included:
  - 1D Components, 1D Core
  - Four Independent Loops
  - Three Core Heat Structures
    - Average Channel (192 Assemblies)
    - Hot Channel (1 Assembly, minus 1 fuel rod)
    - Hottest Rod (1 fuel rod)
  - Full ECCS (3 trains connected to loops 2, 3, & 4)



# Input Model Description (Model w/o LOCA Holes)

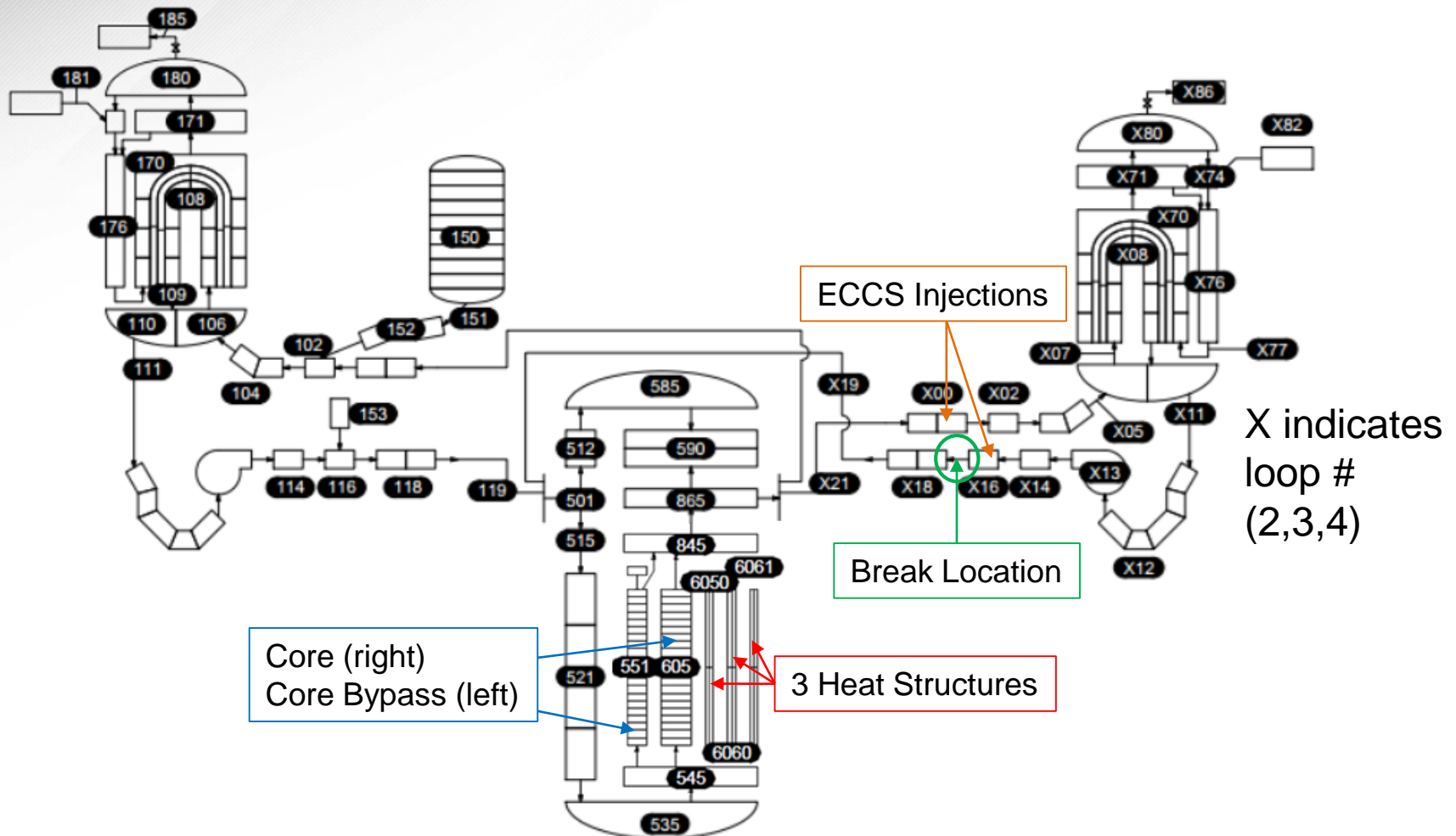

# Input Model Description (ECCS System)

- The model includes the ECCS with three independent safety injection trains connected to loop 2, 3, and 4. Each train includes:
  - One Low Pressure Safety Injection (SI) pump
  - One High Pressure SI pump
  - One Residual Heat Removal (RHR) heat exchanger
  - One Accumulator
- During the long term cooling phase, the heat is removed from the system through the RHR heat exchangers

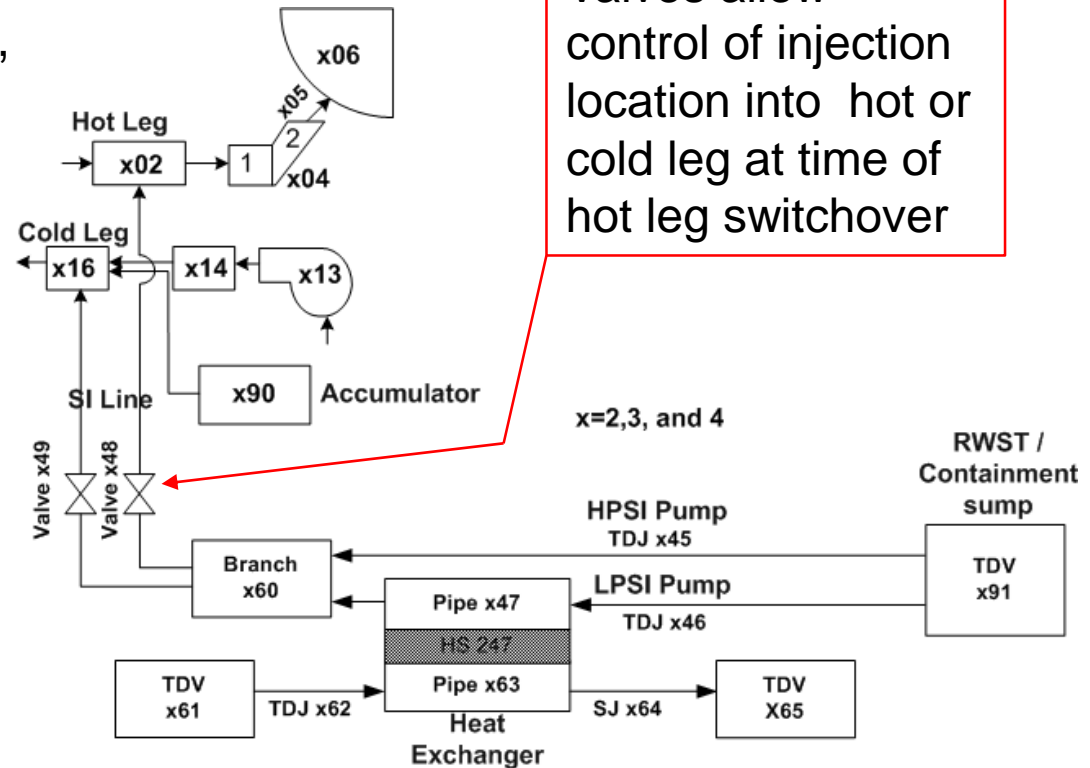



# Input Model Description (Model with LOCA Holes)

- Pressure Relief (LOCA) Holes: A ring of holes through Baffle Plate connecting the Core and Core Bypass
- Simulated 1, 2, and 3 levels
- 1D Model means we take a “lumping” approach
  - All holes at each level combined are into 1 hole (so 1-3 holes)
  - Hydraulic Diameter is that of 1 hole
  - Flow Area is the sum of ALL holes (at each level)
- Friction losses (k-losses) modeled as flow through an orifice:

$$k = \frac{\Delta p}{\rho w_0^2 / 2} = \left( 1 + 0.707 \sqrt{1 - \frac{F_0}{F_1} - \frac{F_0}{F_1}} \right)^2 = 2.914$$

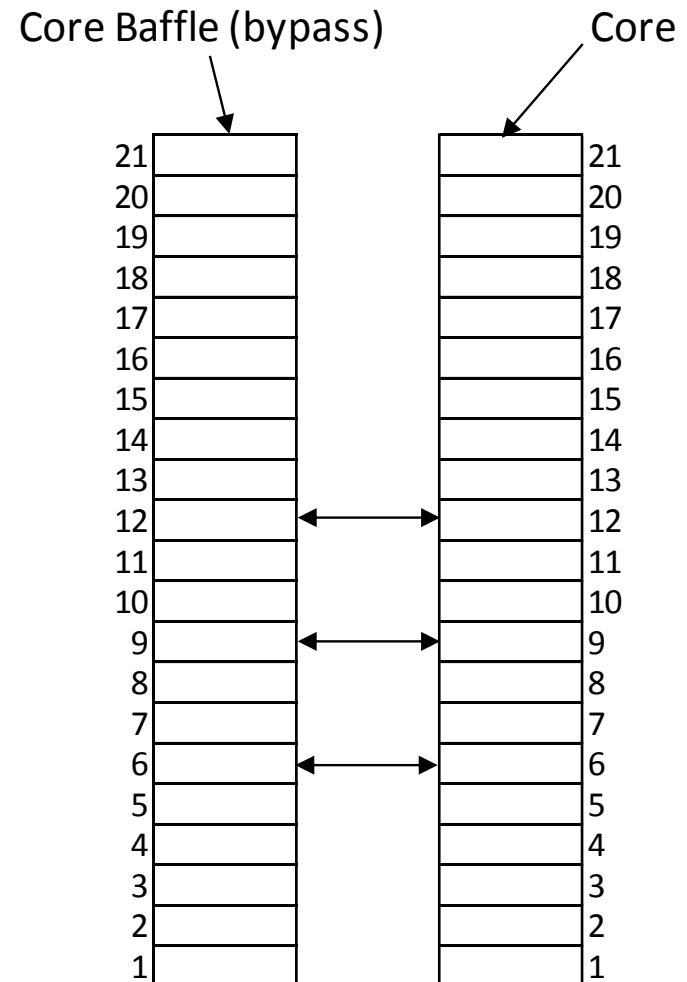

# Input Model Description (Model with LOCA Holes)

- Friction losses (k-losses) modeled as flow through an orifice
  - This model considers k-loss as a function solely of geometry, following this formula:
$$k = \frac{\Delta p}{\rho w_0^2 / 2} = \left( 1 + 0.707 \sqrt{1 - \frac{F_0}{F_1} - \frac{F_0}{F_1}} \right)^2 = 2.914$$
  - $F_0$  is the flow area of the LOCA Hole,  $F_1$  is the area of injection ambient
  - The flow area of the core or bypass channel is significantly larger than individual LOCA Holes, such that:  $F_0/F_1 = 0$
- Other models were considered for flow past an orifice
  - Functions of stream and hole flow velocities
  - Not able to be implemented in RELAP5-3D as there is no control function to adjust k-loss at a junction during the simulation

# Input Model Description (Blockage Simulation)

- Assumed a full and instantaneous blockage of core inlet at sump switchover
  - Debris accumulated at the strainer may penetrate the strainer system and enter the primary system
- Simulated by increasing the forward k-loss (to 1.0E6) at core inlet to prevent flow
  - Backward k-loss unmodified
- Free (unblocked) Bypass

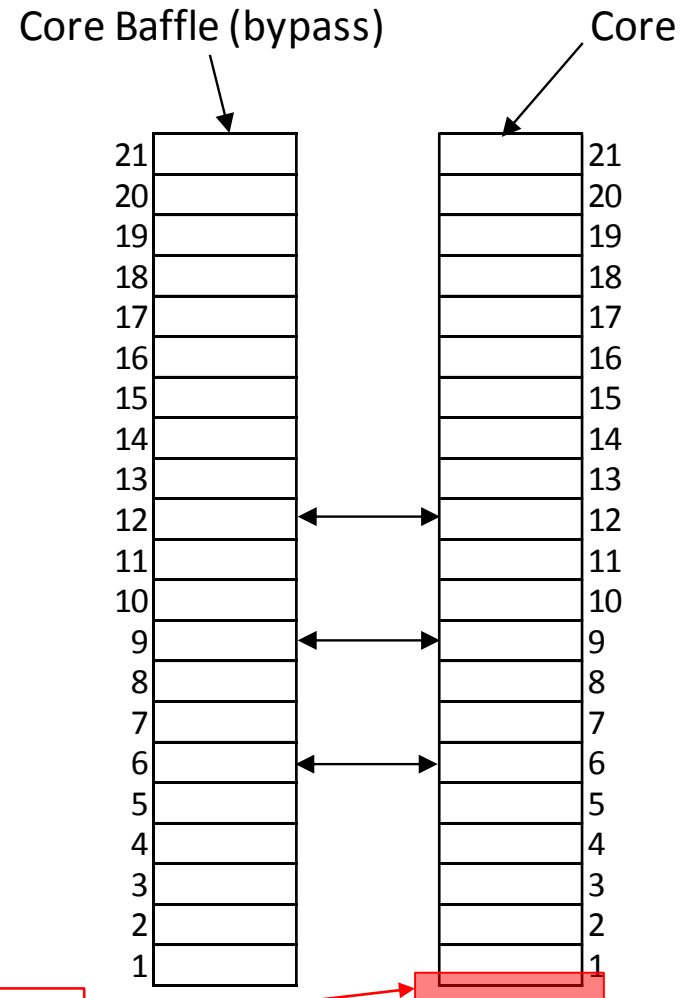

Core Blockage Location

# Simulation Results

Simulation Approach  
Results without LOCA Holes  
Impact of LOCA Holes



# Simulation Results (Simulation Approach)

- 8 total simulations
  - No LOCA Holes
    - With Core Blockage
    - Without Core Blockage
  - With 1 LOCA Hole
    - With Core Blockage
    - Without Core Blockage
  - With 2 LOCA Holes
    - With Core Blockage
    - Without Core Blockage
  - With 3 LOCA Holes
    - With Core Blockage
    - Without Core Blockage
- Parameters of Interest:
  - Peak Cladding Temperature (1478/700 K early/late limits)
  - Core Collapsed Liquid Level
  - Bypass Flow



# Simulation Results (Simulation Approach)

- 4 “base” models were simulated
  - First, the simulation was run at steady-state for 300 seconds (from “-300 to 0 seconds”)
  - Then, the break opened (at “0 seconds”)
  - Sump switchover occurs 1470 seconds later
    - At this time, each simulation was allowed to run normally, to simulate long term cooling without blockage
    - Also, a restart file was created at 1470 seconds and blockage simulations were run for each

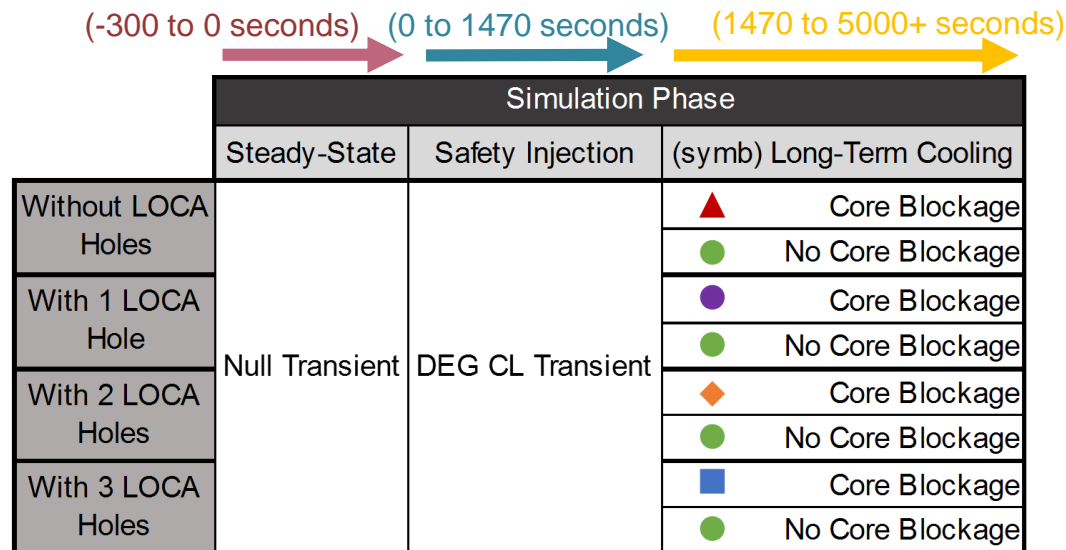

● NOTE: there is negligible difference in results for all unblocked cores, so they are lumped as green results

# Simulation Results (Results w/o LOCA Holes)

- Initial simulations indicated failure

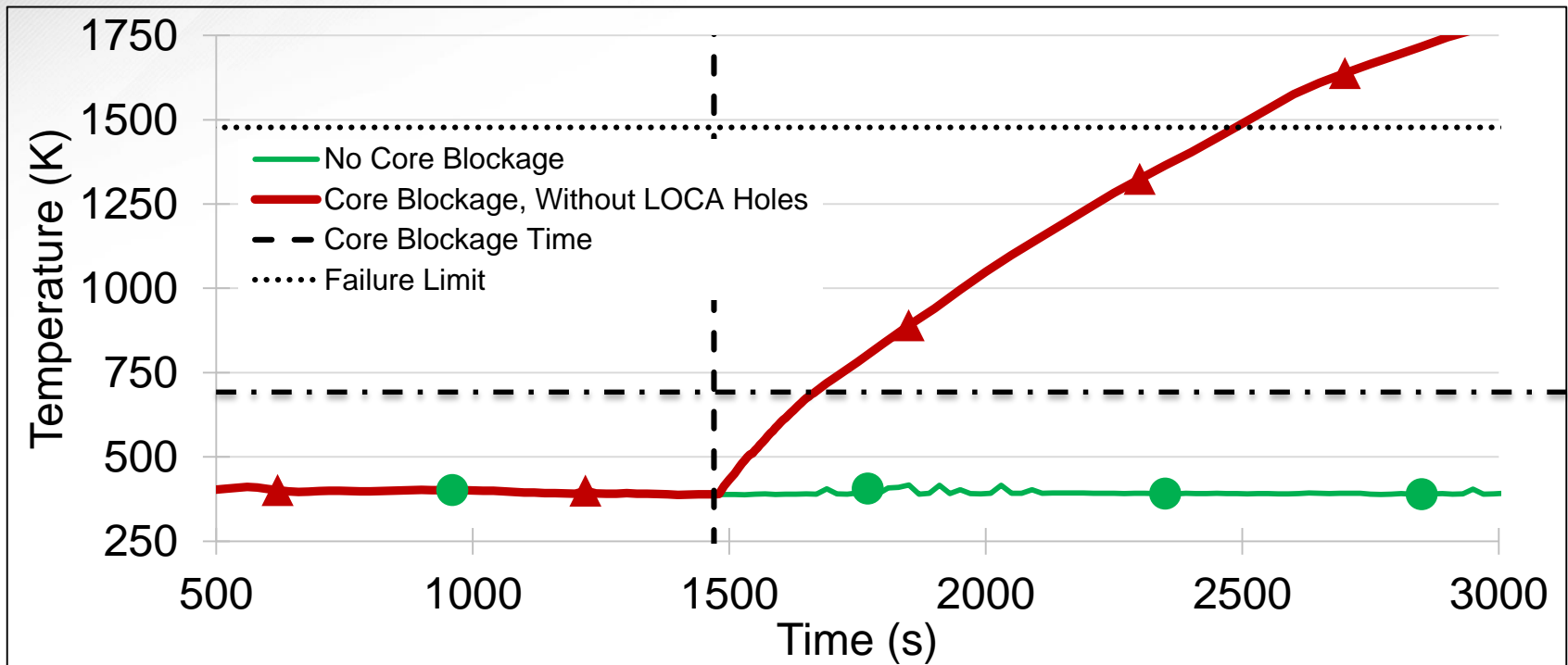

- Why?

# Simulation Results (Results w/o LOCA Holes)

- Supply of coolant to the core is primarily determined by the hydrostatic head between the cold leg (injection location) and the top of the core
- Due to the lower pressure drop between the injection point and the break, the injected water is preferentially directed toward the break and a small fraction goes through the core bypass

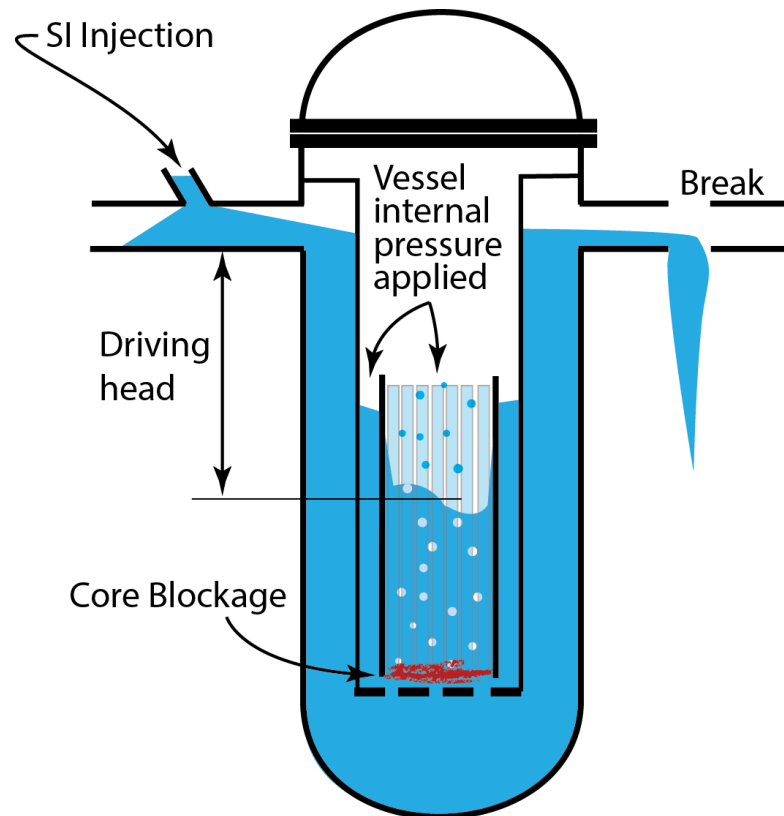



# Simulation Results (Results with LOCA Holes)

- Preliminary thoughts on the possible effects of the LOCA holes on the core coolability:
  - Higher hydrostatic head between the cold leg injection and the levels of holes (coolant doesn't have to make it all the way to the top of the core)
  - Additional coolant should be directed into the core

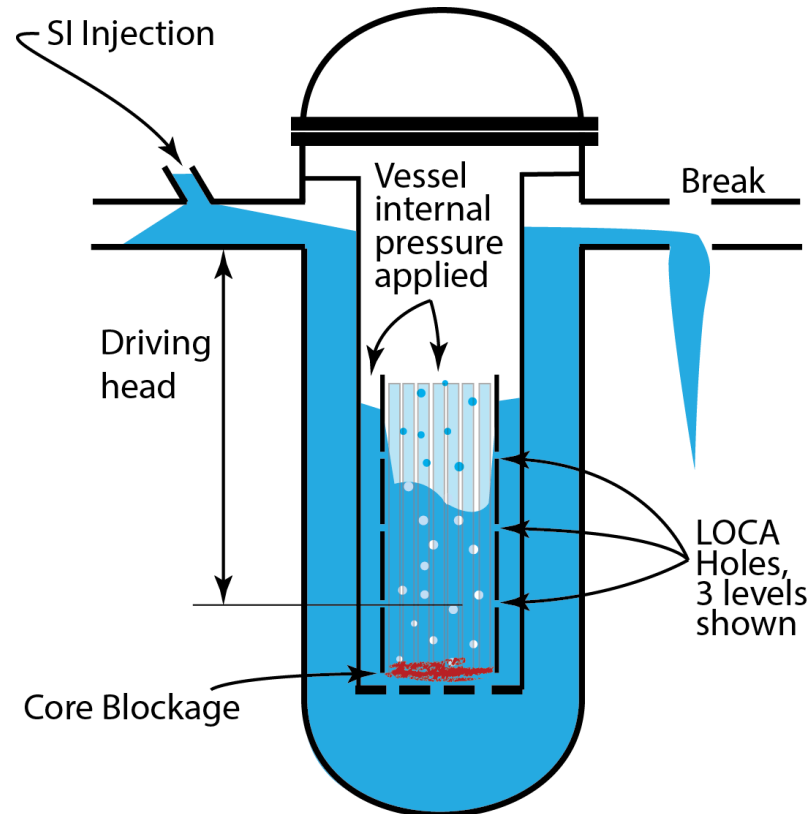

# Simulation Results (Results with LOCA Holes)

- The addition of LOCA holes improved core coolability substantially based on examination of peak cladding temperature

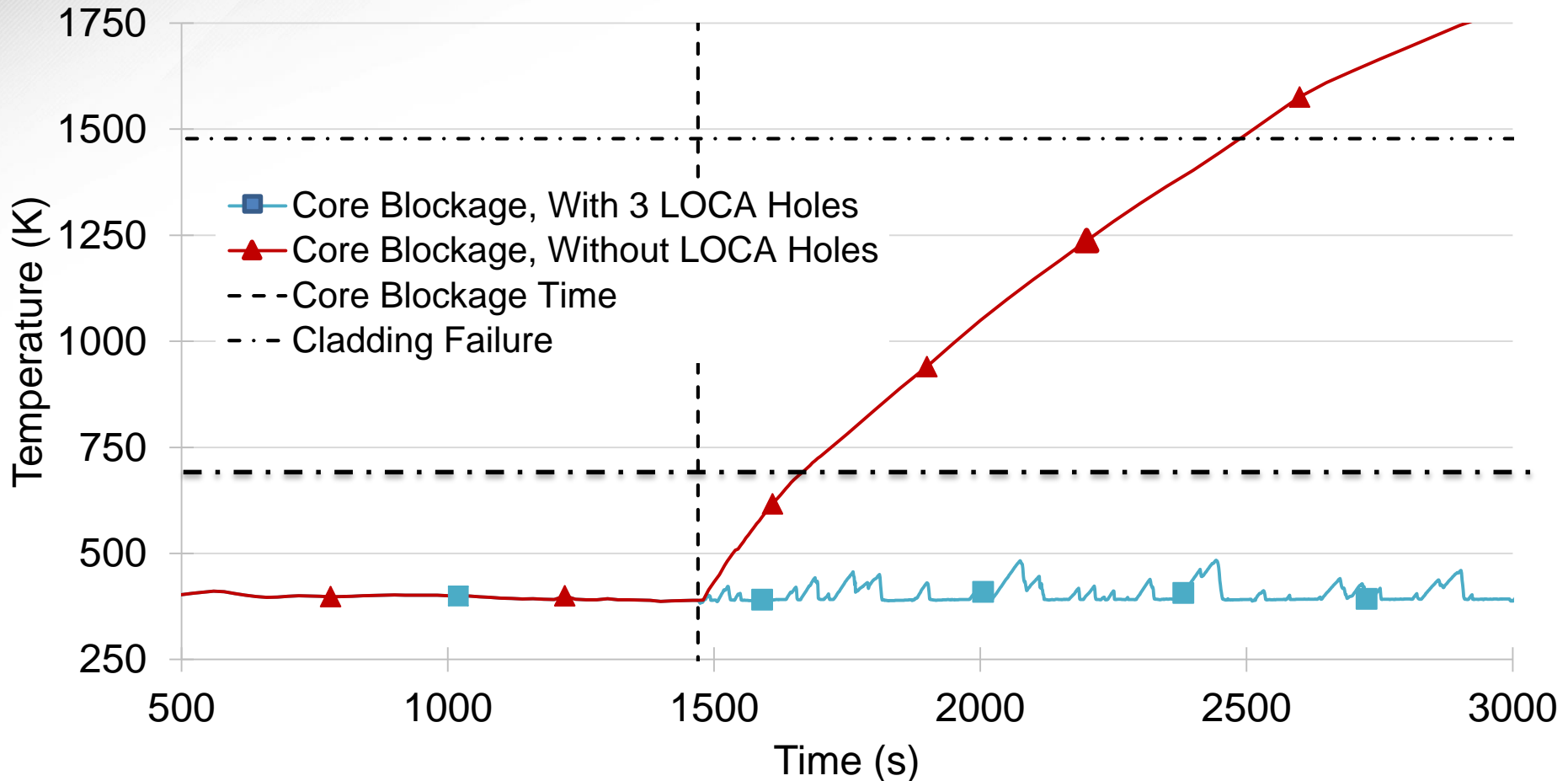

# Simulation Results (Impact of LOCA Holes)

- Effect of the LOCA holes is shown as a higher core liquid level than the simulation without LOCA holes
- Blockage simulations with LOCA holes have a lower total liquid volume than a simulation without blockage, but the amount of liquid is sufficient to maintain an adequate heat removal rate

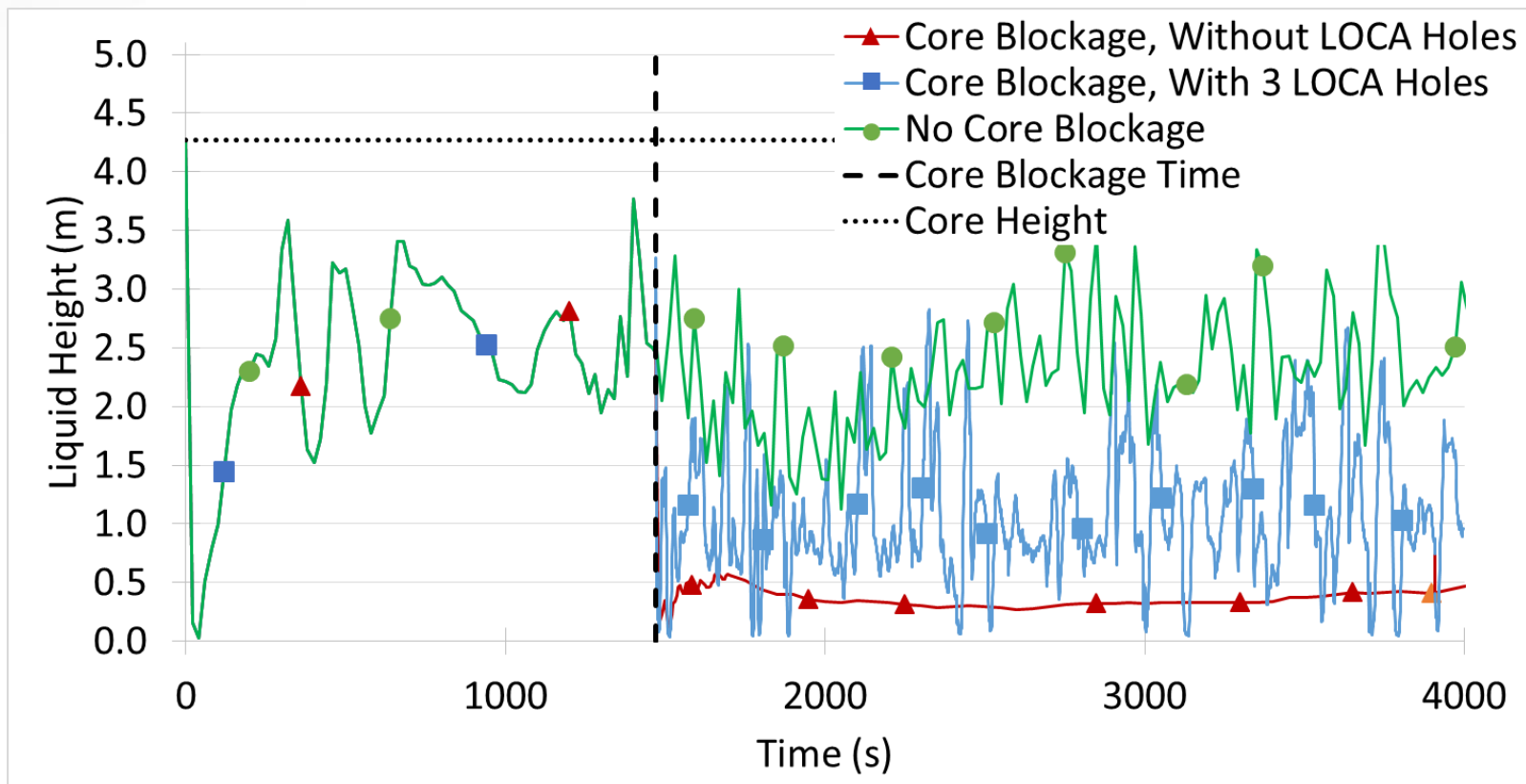

# Simulation Results (Impact of LOCA Holes)

- Bypass integral flow mass represents the total mass of the flow through bypass region over time
- After the core blockage time, bypass inlet mass flow has a net increase as an effect of the presence of the LOCA holes, whilst in the model without the LOCA holes, the net flow was substantially lower

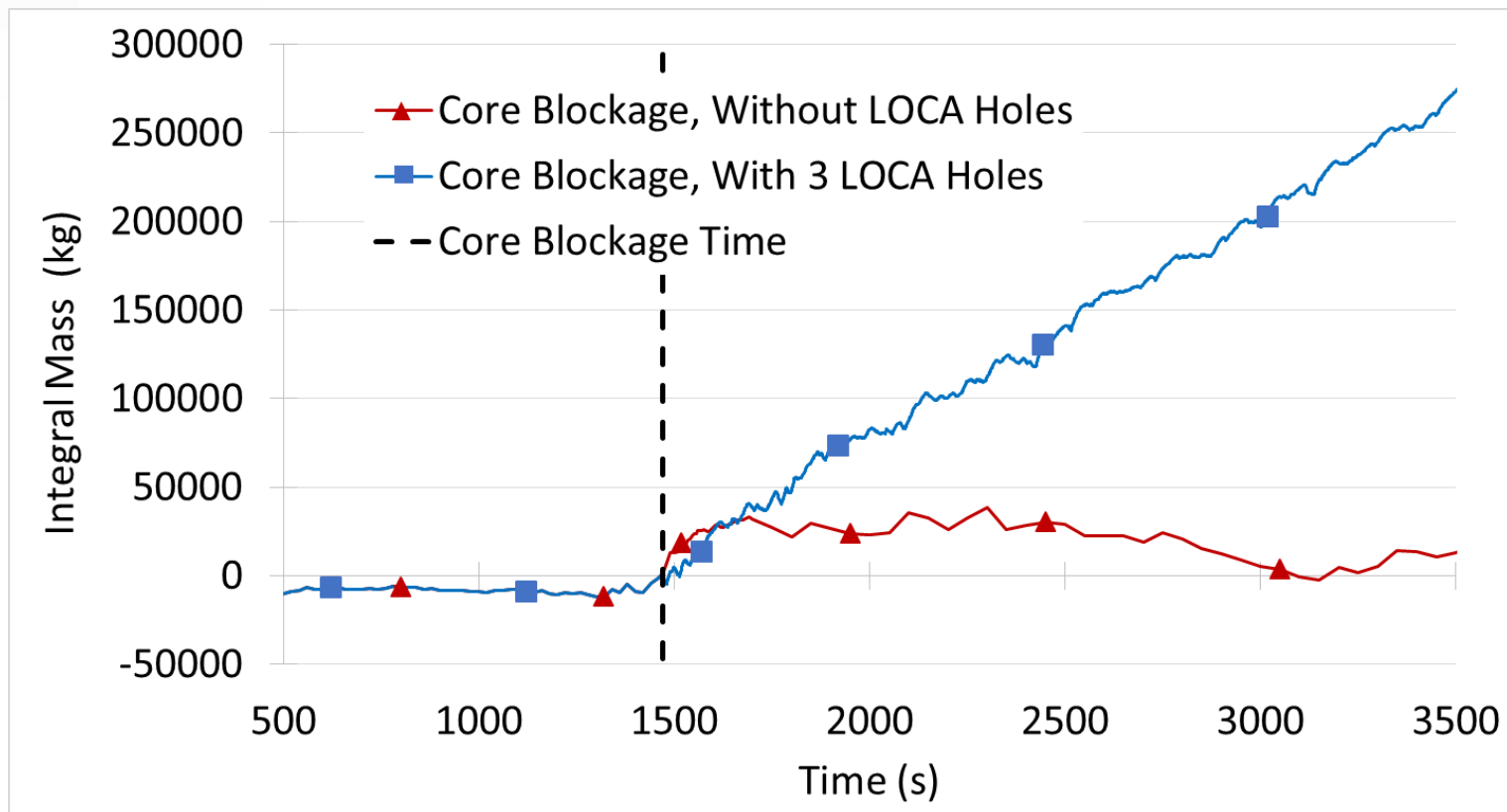



# Discussion

Summary  
Conclusions



# Discussion (Summary)

- Performed RELAP5-3D simulations
  - Cold-leg DEG LOCA with full core blockage
  - Three simulation sets included LOCA holes, one did not
- Determined LOCA hole effect on core flow and coolability by examining:
  - Peak Cladding Temperature
  - Core Collapsed Liquid Level
  - Core Bypass Integral Flow



# Discussion (Conclusions)

- No LOCA Holes
  - Substantially less coolant supplied to core
  - Cladding temperature increased above specified limit
- With LOCA Holes
  - More coolant flowed into the bypass
  - More coolant reached the core itself
  - Core Coolability was improved (Peak Cladding Temperature always below the specified limit)



# **Nomenclature and References**





## ABBREVIATIONS

- CL: Cold Leg
- DEG: Double-End Guillotine
- ECCS: Emergency Core Cooling System
- GSI-191: Generic Safety Issue 191
- LOCA: Loss of Coolant Accident
- LWR: Light Water Reactor
- N/A: Not available
- NRC: (United States) Nuclear Regulatory Commission
- PCT: Peak Cladding Temperature
- PWR: Pressurized Water Reactor
- RCP: Reactor Coolant Pump(s)
- RHR: Residual Heat Removal
- RPV: Reactor Pressure Vessel
- SC: Subcooled
- SH: Superheated
- SI: Safety Injection
- TP: Two-Phase

## SYMBOLS

- $k$ : Frictional energy loss factor (k-loss factor) [unitless]
- $\Delta p$ : Pressure change [Pa]
- $\rho$ : Density [ $\text{kg}/\text{m}^3$ ]
- $w_0$ : LOCA hole flow velocity [m/s]
- $F_0$ : LOCA hole flow area [ $\text{m}^2$ ]
- $F_1$ : Ambient (bypass/core) flow area [ $\text{m}^2$ ]



# References

1. M. R. FARD, "Resolution of Generic Safety Issues," NUREG-0933, U.S. Nuclear Regulatory Commission, (2011).
2. D. V. RAO, C.J. SHAFFER, M.T. LEONARD, K.W. ROSS, B.P. JAIN, "Knowledge Base for the Effect of Debris on Pressurized Water Reactor Emergency Core Cooling Sump Performance," NUREG/CR-6808, LA-UR-03-0880, U.S. Nuclear Regulatory Commission (2003).
3. NEA/USNRC, Debris Impact on Emergency Coolant Recirculation, Workshop Proceedings, Albuquerque, NM, United States, 25–25 February 2004.
4. RELAP5-3D User's Manual, INEEL-EXT-98-00834 (2005).
5. MELCOR computer code manuals vol. 1: Primer and users' guide, version 2.1. Technical Report NUREG/CR-6119, Sandia National Laboratories, September 2008 (2008).
6. NUREG/CR-6770 LA-UR-01-5561, GSI-191: Thermal-Hydraulic Response of PWR Reactor Coolant System and Containments to Selected Accident Sequences (August 2002)
7. R. VAGHETTO, B.A. BEENY, Y.A. HASSAN, K. VIEROW, "Analysis of Long-Term Cooling of a LOCA by Coupling RELAP5-3D and MELCOR," ANS Annual Meeting, Chicago, IL, June 24-28 (2012).
8. R. VAGHETTO, B.A. BEENY, Y.A. HASSAN, K.VIEROW, "Sensitivity Analysis of a Typical Large, Dry Containment Response during a Loss of Coolant Accident using RELAP5-3D and MELCOR," ANS Annual Meeting, Atlanta, GA, June 16-20 (2013).
9. R. VAGHETTO, Y.A.HASSAN, "Study of Debris-Generated Core Blockage Scenarios during Loss of Coolant Accidents using RELAP5-3D," Nuclear Engineering and Design (2013).
10. IDELCHIK, I. E. *Handbook of Hydraulic Resistance*. Pp. 151, 178. 2<sup>nd</sup> Ed. Washington (1986).
11. R. VAGHETTO, A. FRANKLIN, Y.A. HASSAN, "Sensitivity Study of Hypothetical Debris-Generated Core Blockage Scenarios," ANS Annual Meeting, Washington, DC, November 10-14 (2013).

# Simulation Results (Impact of LOCA Holes)

- The impact of the addition of LOCA holes is so substantial, that even a single hole at the lowest elevation was predicted to be sufficient to prevent cladding temperatures from exceeding failure limits

